



ALSTOM STANDARD FOR RAILWAY APPLICATIONS
STANDARD PAINTING PROCESS

TABLE OF MODIFICATIONS

Revision	Publication	Summary of Changes
G	14/12/2020	Modification ASP zones, modification powder paint qualification, Bogie requirements introduction, PPQ template and updates
F1	10/07/2019	Minor update for clarification purpose
F	04/02/19	Document structure to rationalize protection topic Global review prior to publication
E	05/12/16	Modification of humidity cataplast for interior parts on plastic and on FRP parts
D	24/06/15	Modification of the title – mechanical interface
C	12/06/12	Complete revision
B	07/01/11	Cataplast test modification, tables updates, furniture of a model of painting application document
A	28/04/10	Original issue

CONTENTS

1. Purpose.....	5
2. Normative references.....	6
2.1. Standard references.....	6
2.2. Alstom standards references.....	6
3. Terms and definitions.....	7
4. Painting management process.....	8
5. Painting application pre-requisites.....	10
5.1. Pre-treatment preparation.....	10
5.2. Mechanical treatment.....	10
5.3. Chemical treatment.....	11
5.4. Post-treatment preparation.....	11
6. Painting.....	12
6.1. Requirements.....	12
6.2. Standard climatic conditions.....	12
6.3. Parts localization.....	13
6.4. Painting system selection.....	14
6.5. Standard thicknesses.....	15
6.5.1. Standard thicknesses.....	15
6.5.2. Standard thicknesses on mechanical interfaces.....	17
7. Qualification and control.....	18
7.1. Paint process qualification.....	18
7.2. Paint process serial control.....	18
7.2.1. Serial parts and tracking sample part.....	18
7.2.2. Control frequency.....	20
7.3. Functional qualification and control acceptance criteria.....	20
7.4. Visual acceptance criteria.....	24
7.4.1. Control conditions.....	24

7.4.2.	Acceptance criteria according to parts localization.....	25
8.	Drawing / specification indication	26
9.	Applicator deliverables summary	27
10.	Appendices.....	28
10.1.	Appendix 1: Painting application document template.....	28
10.2.	Appendix 2: Inspection sheet	30
10.3.	Appendix 3: Thickness calculation principles	32
10.3.1.	Tolerance to the specified mean value.....	32
10.3.1.1.	General case.....	32
10.3.1.2.	Specific cases	32
10.3.1.3.	Acceptance criteria	32
10.3.2.	Case of imposed minimum: minimum thickness Z.....	33
10.3.3.	Case of imposed maximum: maximum thickness Y	33
10.3.4.	Case of stopper and sizing putties applied with knife.....	33
10.3.5.	What to do if acceptance criteria are not met?.....	33
10.3.5.1.	Case of specified mean	33
10.3.5.2.	Case of imposed minimum	34
10.3.5.3.	Case of imposed maximum.....	34
10.4.	Appendix 4: salt spray method	35
10.5.	Appendix 5: Dew point identification.....	36
10.6.	Appendix 6: Substrates preparation	37
10.7.	Appendix 7: Cataplasma test.....	40
10.8.	Appendix 8: Defect types.....	41
10.9.	Appendix 9: Defect types related to ASP	43
10.10.	Appendix 10: PPQ Template	45
10.11.	Appendix 11: ASP codification before version G	48

1. PURPOSE

This ALSTOM Standard describes paint systems used to achieve a desired level of performance.

Any deviation to the requirements of the current specification must be formalized through a complete argument file (clause by clause) which must be validated by ALSTOM.

All mechanical, chemical, visual or dimensional characteristics that do not meet the requirements of this ALSTOM Standard will result in rejection of the corresponding product.

To its convenience, the applicator will choose either the EN or US normative framework in compliance with local regulations.

2. NORMATIVE REFERENCES

2.1. STANDARD REFERENCES

Reference	Title
ASTM B117	Standard Practice for Operating Salt Spray (Fog) Apparatus
ASTM D714	Standard Test Method for Evaluation Degree of Blistering of Paints
ASTM D523	Standard Method Test for Specular Gloss
ASTM D610	Evaluation Degree of Rusting on Painted Steel Surfaces
ASTM D2794	Standard Test Method for Resistance of Organic Coatings to the Effects of Rapid Deformation (Impact)
ASTM D3359	Standard Test Methods for Measuring Adhesion by Tape test
ASTM D4417	Standard test Methods for Field Measurement of Surface Profile of Blast Cleaned Steel
ASTM D7091	Non-Destructive Measurement of Dry Film Thickness of Nonmagnetic Coatings Applied to Ferrous Metals and Nonmagnetic, Nonconductive Coatings Applied to Non-Ferrous Metals
EN 13523-27	Corrosion resistance under cataplasma test
EN 13261	Wheelsets and bogies – Axles – Product requirements
ISO 8501-1	Preparation of steel substrate before application of paints and related products. Visual assessment of surface cleanliness. Rust grades and preparation grades of uncoated steel substrates and of steel substrates after overall removal of previous coating.
ISO 2409	Paint and varnishes – Cross-cut test
ISO 2808	Paint and varnishes – Determination of film thickness
ISO 2813	Paint and varnishes – Determination of specular gloss of non-metallic paint films at 20 degrees, 60 degrees and 85 degrees
ISO 4287	Geometrical Product Specification (GPS) – Surface state: profile method
ISO 4628-2	Evaluation of blistering Degree
ISO 6272-2	Paint and varnishes – Rapid-deformation (impact resistance) - Part 1: Falling weight test, large area indenter
ISO 9142	Adhesives - Guide for the selection of standard laboratory ageing conditions for the testing of bonded joints
ISO 12944-3	Corrosion Protection of Steel Structures by Protective Paint Systems - Part 3: Design Considerations
ISO 9227	Corrosion tests under artificial atmospheres – Salt spray tests
ISO 12944-3	Corrosion Protection of Steel Structures by Protective Paint Systems - Part 3: Design Considerations
SSPC-VIS1, SP5/NACE No1 or SP10/NACE No2	White and Near-White Metal Blast Cleaning

2.2. ALSTOM STANDARDS REFERENCES

Reference	Title
DTRF 150611	Surface Protection Catalogue

3. TERMS AND DEFINITIONS

TERM	DEFINITION
Applicator	Company implementing the painting process
Formulator	Paint producer
PSQ	Paint System Qualification
PPQ	Paint Process Qualification
PPSC	Paint Process Serial Control

4. PAINTING MANAGEMENT PROCESS

Global painting management process can be subdivided into the following main activities:

- Paint System Qualification (PSQ)
 - Used to qualify new paint systems and is realized under ALSTOM responsibility. Once paint system is qualified, it is then implemented in DTRF 150611
- Preliminary operations
 - Pre-treatment operations
 - Surface treatment
 - Post treatment operations (if any)
- Selection of painting system compliant with the specification
- Painting process qualification (PPQ), described in § 7.3
- Paint application (see figure below for details)
- Painting Process Serial Control (PPSC)

In parallel, a painting process audit must be performed to ensure the level of performance of the paint applicator. In case of modification of the process (change of treatment, change of quality control....), the modified steps should be re-audited.

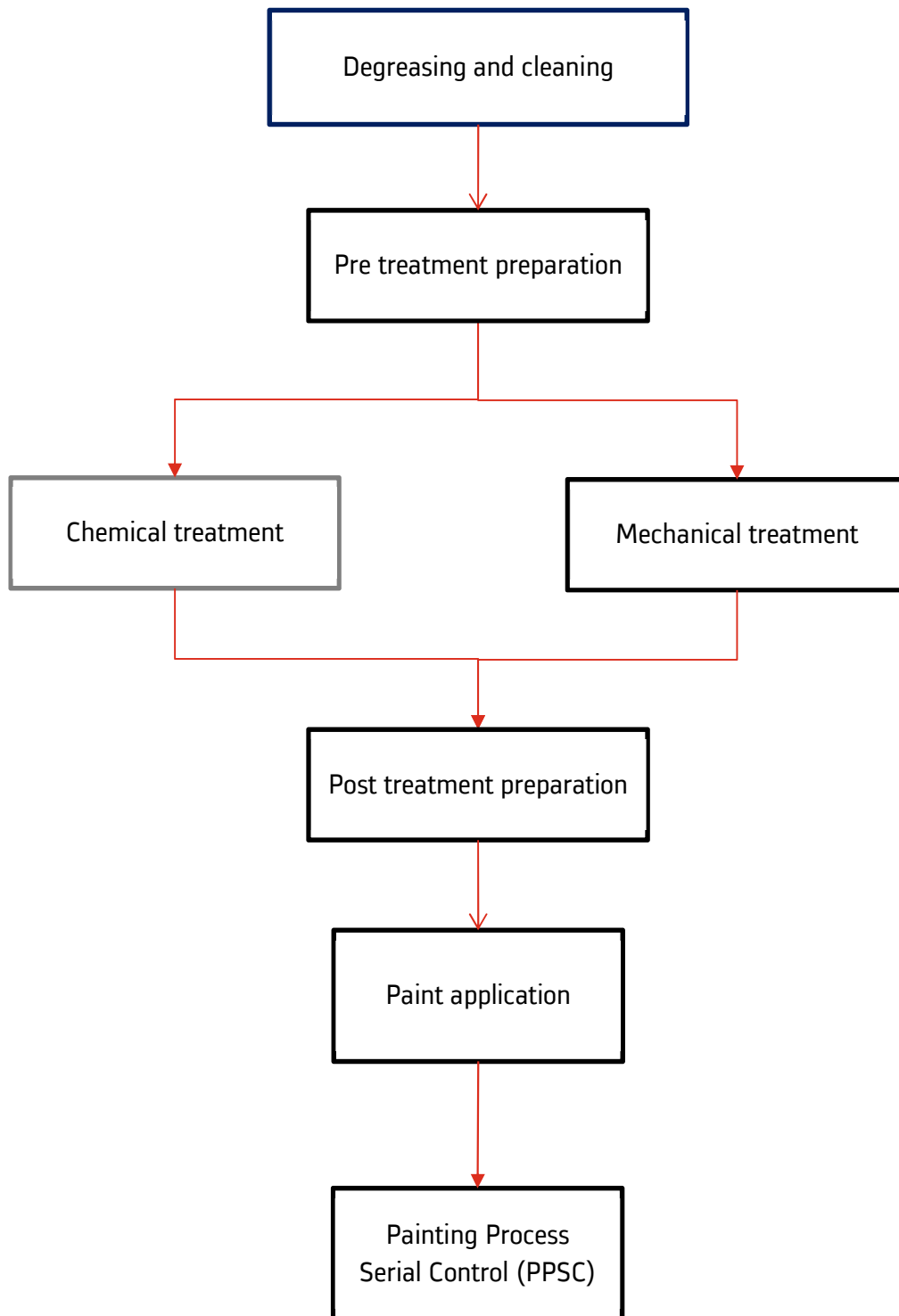

Figure 1: Painting management process summary

5. PAINTING APPLICATION PRE-REQUISITES

Before applying the paint system, the substrate must be clean (free of grease, oil and dry). The substrate can be prepared by mechanical or chemical treatment. This treatment creates the necessary surface condition for a good adhesion of the complete paint system.

5.1. PRE-TREATMENT PREPARATION

Sharp edges are prohibited and must be broken with a minimum radius of 2mm (0.08 inch) according ISO12944-3 (countersunk, stripping, etc.) on areas exposed to humidity or abrasion – zones 1, 2, 3 and 6 according §6.3 (depending on the thickness of the metal sheet and the paint system). All CO2 laser cutting must be mechanically pickled before painting (preferred laser cutting under nitrogen or argon). Pre-applying method is mandatory for the most exposed parts.

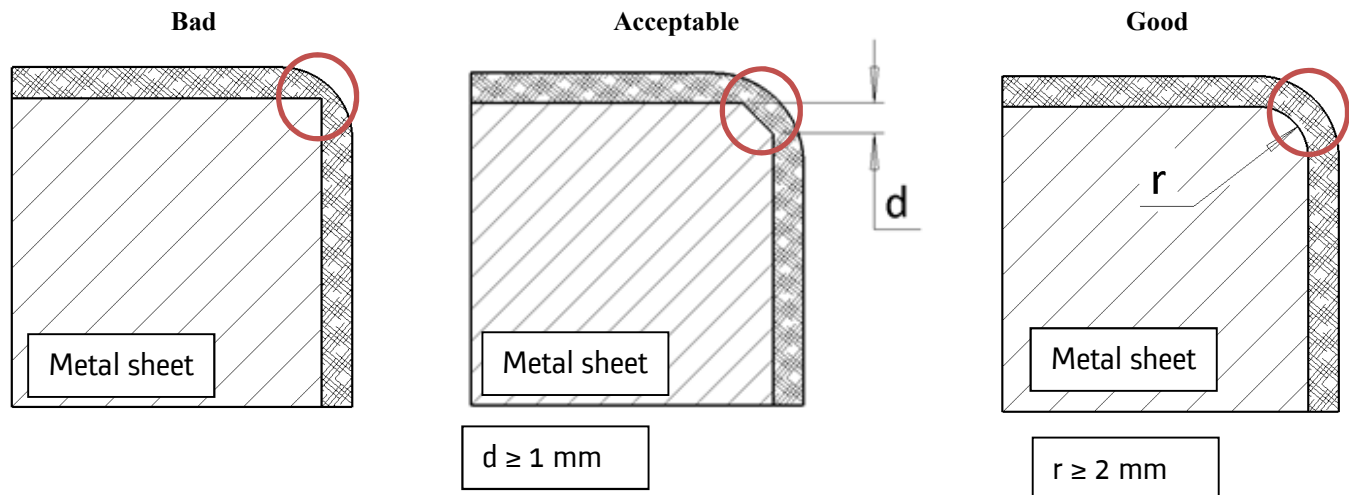

Figure 2: Sharp edges management

5.2. MECHANICAL TREATMENT

Treatment by shot blasting is done with below media:

	Corundum	Steel abrasive	Stainless steel abrasive	Adapted abrasive (glass, plastic media, ...)
Carbon steel	X	X		X
Stainless steel	X		X	X
Aluminum	X			X
Composite				X

If a treatment by shot blasting is not possible, others mechanical treatments could be proposed and applied such-as:

- Sanding for composites
- Sanding, flame, cold plasma or laser for plastic materials

5.3. CHEMICAL TREATMENT

The choice of this type of treatment is under the responsibility of the applicator.

The applicator must present an approval request record or present a Qualicoat, GSB or BS, Qualisteelcoat qualification type.

This record must contain Compliance statement with respect to ENG-FMR-001.

5.4. POST-TREATMENT PREPARATION

Coating delay after chemical and mechanical treatment

For any part, except car body shell, the maximum time between the start of the chemical or the mechanical treatment and the end of application of the first coat should not exceed **16 hours**.

For car body shell, maximum time between start of chemical or mechanical treatment and end of application of the first coat should not exceed **72 hours for steel and 7 days for aluminum**.

During this interval, the part must be kept in a closed room at a minimum temperature of 18°C (64°F) and a maximum hygrometry of 80%.

Any overshoot of these criteria relative to additional operations between surface preparation and application of the first coat of paint (area masking, assembly, transport...) or atmospheric conditions not respected, must be submitted to a deviation request with validation tests (see §7.3).

In any case, no appearance of corrosion must be observed.

The chemical or mechanical treatment must be done again if a corrosion defect appears or if the maximum delay has been exceeded.

6. PAINTING

6.1. REQUIREMENTS

For responsibility concerns, it is recommended to use products coming from the same formulator for each paint system, liquid or powder. The responsibility for painted parts falls on the applicator who applied the paint system. The applicable paint systems are approved by ALSTOM; it is mandatory to use paints commodity catalogue DTRF 150611.

When several options are proposed in this document, the choice is made in accordance with the design and after techno-economic analysis under the responsibility of project. The chosen option is indicated in the application document.

6.2. STANDARD CLIMATIC CONDITIONS

The conditions of application should be compliant with the technical data sheet of the formulator and in a general way here are the standard conditions:

	Temperature	Hygrometry
Water borne paint system	Recommended 18°C – 30°C (64°F – 86°F)	Between 30% and 75%
Solvent borne paint system	Recommended 18°C – 30°C (64°F – 86°F)	Maximum 80%
Powder paint	15°C – 45°C (59°F – 113°F)	Maximum 85%

The temperature of the part to be painted must be above 3°C (5°F) to the dew point (see Appendix 5).

During the whole process, the applicator must also ensure a satisfactory level of environment cleanliness and the total absence of contamination sources which could degrade the process robustness.

6.3. PARTS LOCALIZATION

Existing zone types are described below:

- Zone 1- External visible – Sides and lower parts of sides, including doors and front end
- Zone 2 - External not visible - Roof, underframe and ends exposed to sunlight
- Zone 3 - External not visible - Roof, underframe, ends not exposed to sunlight, bogies
- Zone 4 - Internal visible
- Zone 5 - Internal not visible – Not apparent parts or located in technical room, intercirculation
- Zone 6 - Internal not visible – Sensitive zones, walking platforms, toilets zones, air tanks interior
- Zone 7 - Internal visible – Driver cabin
- Zone 8 - Internal visible - Zones exposed to shocks
- Zone 9 – External not visible – Bogies Axle
- Zone 10 – External not visible – Anti roll bar and bogies spring

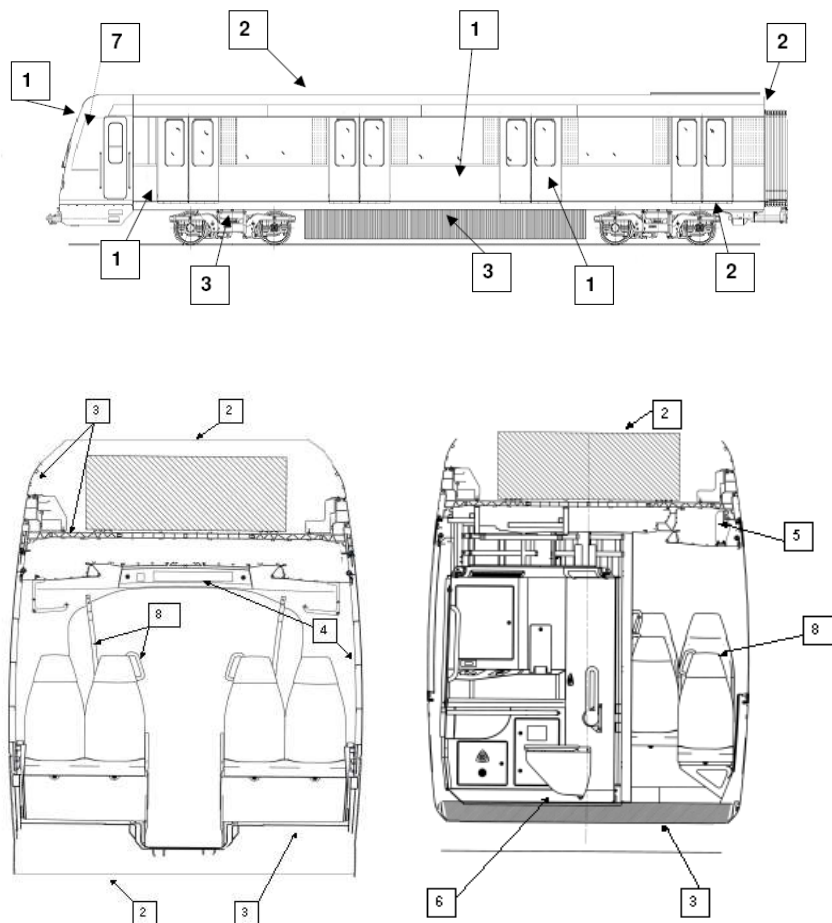

6.4. PAINTING SYSTEM SELECTION

A general table of standard processes (surface treatment regarding substrates, paint system according to parts localization) is given below. Based on DTRF150608, project painting expert describes applicable painting process in the painting technical specification. All the information should be documented with the application document and checked by the painting expert in order to state if the process is compliant with the painting specification. This document must contain the full description of the process and the definition of the paint systems to be employed in order to ensure the protection against corrosion of the supplied parts (template given in appendix 1).

		MATERIAL with appropriate surface preparation						
		STEEL	ALUMINUM	STAINLESS STEEL	STEEL OR IRON CASTING PART	COMPOSITE	GALVANIZED	
INTERIOR	VISIBLE	PT* PBC PO	PT* PBC PO	PT* PBC* PO	PT* PBC* PO PPP	IT* IBC	PT* PBC* PO	
	NON VISIBLE	MI PT P (only for parts) PO	MI PT P PO PPP	MI PT P PO	MI PT P PO	MI IT	MI PT P PO	
EXTERIOR	VISIBLE + UV	PT* PBC* PPP	PT* PBC* PPP	PT* PBC* PO PPP	PT* PO PPP	IT* IBC*	PT* PBC* PO PPP	
	NON VISIBLE + UV	ME PT PPP	ME PT PO PPP	ME PT PO PPP	ME PT PO PPP	ME IT	ME PT PO PPP	
	NON VISIBLE	ME MI PT PPP PM	ME MI PT PO PPP PM	ME MI PT PO PPP PM	ME MI PT PO PPP PM	ME MI PT PO PPP PM	ME IT	ME MI PT PO PPP
		PO	PO					
MATERIAL with appropriate surface preparation								

		STEEL	ALUMINUM	STAINLESS STEEL	STEEL OR IRON CASTING PART	COMPOSITE	GALVANIZED
SPECIFIC CASES	CORROSION	MI PT PPP	MI PT PO PPP	MI PT PO	MI PT PPP		MI PT PPP
	SHOCKS	PO	PO	PO PPP	PO PPP		
	DRIVER CABIN	PT* PO	PT* PO			IT*	

PT	Primer + topcoat	MI	Monocoat interior
PBC	Primer + base/clearcoat	PO	Powder
PPP	Primer powder + finishing powder	IT	Intermediate + topcoat
ME	Monocoat exterior	IBC	Intermediate + base/clearcoat
P	Primer	PM	Primer + Monocoat (only for bogie)

Primer could be replaced by E-coat after mechanical validation.

Nota (*): putty and intermediate if necessary

All **liquid paint systems** must be documented by an Industrial Technologic Process (ITP or PTI) performed by the paint formulator. This ITP must stipulate the different parameters to be respected during the painting process.

For powder coatings, the process must meet the conditions given in the technical data sheet from the paint formulator.

6.5. STANDARD THICKNESSES

Putty can be applied on parts, for aesthetic reasons.

The maximum thickness of the dry film after sanding must be less than or equal to 1 mm (0.04 inch) depending on the project requirements. However, occasionally on certain areas, to offset major flatness defects, this thickness may exceed 1 mm (0.04 inch). In this case, a drawing of the part with localization of these areas is to be attached to the application document.

6.5.1. STANDARD THICKNESSES

The standard thicknesses regarding paint layer used are given in the following table. These values are ALSTOM recommendations and must be used unless otherwise specified by supplier (See appendix 3 for tolerance calculation).



Systems	Composition	mil			µm		
		Average	Mini Average xa	Maxi Average xb	Average	Mini Average xa	Maxi Average xb
Liquid Paint							
1 layer	Wash Primer	0,3	0,2	0,4	8	6	10
1 layer	Primer	2,0	1,6	3,1	50	40	80
2 layers	Primer	2,0	1,6	3,1	50	40	80
	Primer + Topcoat	3,9	3,1	6,3	100	80	160
2 layers	Intermediate	2,0	1,6	3,1	50	40	80
	Intermediate + Topcoat	3,9	3,1	6,3	100	80	160
	Primer + Monocoat	7,5	5,9	9	190	150	230
3 layers (putty if necessary)	Primer	2,0	1,6	3,1	50	40	80
	Primer + Intermediate	3,9	3,5	7,1	100	80	160
	Primer + Intermediate + topcoat	5,9	5,1	10,2	150	120	240
3 layers (putty or intermediate if necessary)	Primer	2,0	1,6	3,1	50	40	80
	Primer + Base (eg (20 +/- 2)µm)	2,8	2,3	4,0	70	58	102
	Primer + Base + Clearcoat	4,7	3,9	7,6	120	98	192
4 layers (putty if necessary)	Primer	2,0	1,6	3,1	50	40	80
	Primer + Intermediate	3,9	3,5	7,1	100	80	160
	Primer + Intermediate + Base (eg (20 +/- 2)µm)	4,7	4,3	8,0	120	98	182
	Primer + Intermediate + Base + Clearcoat	6,7	5,8	11,5	170	148	292
Monocoat	Monocoat (eg 100 µm)	3,9	3,5	5,1	100	90	130
Powder Paint							
Powder finishing	Powder	2,8	2,4	3,9	70	60	100
Primer Powder + Powder finishing	Primer Powder + Powder	5,5	4,7	7,9	140	120	200
Primer Cataphoresis + Powder	Primer Cataphoresis	0,8	0,7	0,9	20	18	22
	Primer Cataphoresis + Powder finishing	3,5	3,1	4,8	90	78	122

6.5.2. STANDARD THICKNESSES ON MECHANICAL INTERFACES

The **protection on mechanical interface** painted with are **bolted, screwed or riveted**, must be compliant with the specifications indicated on the drawings in order to reduce the effect of settlement: ASP **A**ssembly **S**urface **P**rotection.

Protection	Technical solutions
ASP00	Raw surfaces
ASP80	Maximum thickness of the paint system of 80 µm
ASP160	Maximum thickness of the paint system of 160 µm
ASPH	Trace of paint accepted into the hole

In Appendix 11, please find the previous codification of ASP zones, before version G of the current document. Main defect types related to ASP depicted in Appendix 9 are not accepted.

Revision after assemblies

In case of paint masking upper to mechanical interface, touch-up or seal is required after assembly to insure a good protection of the area against corrosion. It is suggested to use a primer in the ASP zones in order to have a color difference and to carry out the revision of this zone if necessary. Revision must be described in the assembly document defined by engineering.

7. QUALIFICATION AND CONTROL

Applicator must demonstrate painting process robustness during all contract duration:

- Before mass production through a **paint process qualification** (PPQ)
- During mass production with a **paint process serial control** (PPSC).

Process audit completes the qualification process.

7.1. PAINT PROCESS QUALIFICATION

During control phase, if the surface does not allow reliable and precise measurements (e.g. casting parts, composite parts...), the applicator can perform measurements on tracking sample part.

The tests must be performed on representative components plates (ISO material, ISO paint system not including color, ISO process even surface finishing). When the protection is applied on several supports (material or different surface finishing), all the tests must be repeated for each type of material (e.g. aluminum versus steel) taking from them every time roughness surface (Ra) the lowest.

A report template example PPQ is given in Appendix 10.

In case of major change (5M), validation process is mandatory.

7.2. PAINT PROCESS SERIAL CONTROL

An inspection sheet related to painting activities (see example in Appendix 2) must be written by all applicators prior to production start.

This inspection sheet describes all specific controls to be performed at each step of painting process.

Main characteristics (content, frequency...) of controls to be realized before production start as well as during production are described in the below sections.

Reports results and inspection sheet must remain available for ALSTOM for a 10-year duration period till the end of manufacturing.

7.2.1. SERIAL PARTS AND TRACKING SAMPLE PART

Controls are made on each part; each part being accompanied by a tracking sample part.

Tracking sample part, which minimum format is 100 x 100mm (4 inch * 4 inch), is made of same material as serial parts.

Same process as serial parts is applied on tracking sample part, from surface treatment to drying.

A strip of each sublayer must be visible and applied products must be identified (reference, batch number).

ID#XXXXXXX	Date: XX/XX/XXXX
(if no pretreatment, leave bare and mask)	
Primer and mask	
Intermediate and mask	
Basecoat	
Clearcoat	

For important production series (> 20 parts per team), controls, except appearance control, can be made at series level.

Each series will be accompanied by a tracking sample part, integrated to the painting process.

Painting application is to be realized by the same painter, with a single painting preparation or a single batch, during a single slot (8 h). Tracking sample must be kept for 1 year minimum.

7.2.2. CONTROL FREQUENCY

Below table lists suggested control frequency for **important production series** (> 20 parts per team), depending on parts localization:

Parts localization (based on §6.2)	Control type					
	Surface state after mechanical treatment	Dry film thickness	Cross cut behavior	Impact resistance (powder)	Gloss	Color and visual appearance
Internal and external visible (localizations 1, 4, 7, 8)	1/1	1/1	1/1 *	1/1 *	1/5	1/1
Internal and external not visible (localizations 2,3, 5, 6, 9, 10)	1/1	1/5	1/1 *	1/1 *	1/20	1/20

**on tracking sample part or directly on part with customer's agreement* Validation tests: color and appearance

Any degradation, perforation of the topcoat layer, not complying with these criteria, must be corrected.

7.3. FUNCTIONAL QUALIFICATION AND CONTROL ACCEPTANCE CRITERIA

The table, in the following pages, precise functional and characteristics requirements of the painting parts which must be met by the applicator during qualification phase or during serial control phase, except for axles which must follow EN13261.

In the inspection phase, if the surface does not allow "reliable" and repetitive (e.g. castings parts, composite part...), the applicator can perform measurements on a tracking sample.



Functional characteristic	Standard specification	Additional information	Acceptance criteria	PPQ	PPSC	Substrate	
Surface state	To evaluate Sa : ISO8501-1 for Steel and Refer Appendix 6 for Aluminum.	Cleanliness level Sa Roughness Ra	2.5 (except steel Zn) 3.2 µm to 12.5 µm 3.2 µm to 6.3 µm for steel Zn			Steel, Al,Stainless steel, Iron Casting	
	To evaluate Ra: ISO 4287 for both steel & Aluminum. <i>SSPC-VIS 13 for hand tool cleaned surfaces ASTM-D4417 Appendix 6 for aluminum</i>	<i>Level of Cleanliness Testex test strips</i>	<i>SSPC SP 5 or 10, NACE 1 or 2 1-2,5 mil surface profile (Testex test strips)</i>	X	X		
Dry film thickness	ISO 2808 <i>ASTM-D-7091-13</i>	Depending on configuration, a drawing with localization of measurement points can be requested by site painting expert		See § 6.5	X	X	All
		Number of measurement points wrt part surface					
		Surface (squared or linear meters)	Regularly located measurement points				
		<1	3 to 10				
		1 to 10	10 to 20				
10 to 100	20 to 50						
Color and appearance	§7.4	Complete details in §7.4.	Color aligned with secondary etalon	X	X	All	



Adhesion test	ISO 2409	To be realized on representative part with iso-material configuration (tracking sample part or on non-visible area of the part) Method: depending the DFT up to 60 µm : cross cut test 1mm spacing 61 µm to 120 µm : cross cut test 2mm spacing 121 µm to 250 µm : cross cut test 3 mm spacing 250 µm : X cut	Cross cut test: class 0 or 1	X	X	All
	ASTM-D-3359	The peeling test after crosscut is realized after brushing using a pressure-sensitive tape with a peel strength between 6 N/cm and 7,5 N/cm on steel panel according D3330 method A. The crosscut is checked with the naked eye. This control is realized 14 days later for solvent based paints, 21 days later for water-based paints or mixed paint systems, 7 days later accelerated drying, within 24h powder paints	<i>Cross cut test: quotation equal to 5A/5B or 4A/4B</i>			
Specular gloss	EN ISO 2813 ASTM-D-523	Specular gloss is measured with a gloss meter at 60° Except for textured aspect	Value aligned with specification or drawing	X	X	All
			Glossy Clearcoat: gloss value is ≥90 for solvent borne or ≥85 for waterborne; -5 GU isolated points are accepted			
			Glossy Topcoat, monocoat or powder coat: - 10 GU with respect to requirement with isolated points at maxi - 15			
			Satin: Satin value is expressed as a tolerance: 30 ≤ GU ≤50			
Mat: An average deviation limited to +1 GU with respect to requirement is accepted. Example: mat < 5, for opaque color tolerance maxi 6, for metallic color tolerance maxi 8						



<p>Polymerization test for powder paint</p>	<p>/</p>	<p>Saturate a swab of cotton wool with MEK solvent. Within 30 seconds, rub it lightly back and forth 30 times in each direction over the part to be tested. Wait 30 minutes before making the assessment. The polymerization quality is assessed according to the following ratings:</p> <ol style="list-style-type: none"> 1. The coating is very dull and quite soft. 2. The coating is very dull and can be scratched with a fingernail. 3. Slight loss of gloss (less than 5 units for high gloss) 4. No perceptible change. Cannot be scratched with a fingernail. 	<p>Ratings 3 and 4 are satisfactory. Ratings 1 and 2 are unsatisfactory. For powder coatings, this test is optional in in-house control; it is merely indicative and cannot alone cast doubt upon the quality of the coating.</p>	<p>X</p>	<p>X</p>	<p>Steel or alu only for powder paint</p>
<p>Cataplasm ageing</p>	<p>EN 13523 section 27 ISO 2409 ISO 4628-2</p> <p><i>Appendix 7 ASTM-D-714 ASTM-D-3359</i></p>	<p>Test to be realized after total cross linking of the paint system (without putty). Materials: strips of padding or cotton for automotive polishing, deionized water</p> <p>Samples preparation: padding is entirely saturated with water and laid down on the whole surface</p> <p>Test duration: 7 days</p> <p>Blistering quotation according to ISO 4628-2 after samples cooling and drying</p> <p>Cross cut test after 24 hours duration rest period</p>	<p>Test temperature: 60°C ±3°C (158.° F) Except for internal composite and plastic parts at 40°C±3°C (104°F)</p> <p>Cross cut test: inferior or equal to 2</p> <p>Blistering: Max degree 3, max size 2 (≤3(S2)) Max degree 2, max size 3 (≤2(S3))</p> <p><i>Cross cut test: quotation equal to 3A/3B or better Blistering: Max. Size6 and few density Max. Size 8 and max medium density</i></p>	<p>X</p>		<p>All</p>
<p>Corrosion resistance</p>	<p>ISO 9227 ISO 4628-2 ISO 4628-3 Appendix 4</p> <p><i>ASTM-B-117 or ASTM G85 A1 ASTM-D-714 ASTM-D610 Appendix 4</i></p>	<p>Test to be realized after total cross linking of the paint system.</p> <p>Test to be realized on a representative part (iso configuration for material)</p> <p>Neutral salt-spray (NSS) for steels according ISO9227 / <i>ASTM B 117</i> or Acetic salt spray (AASS) for aluminum alloys according ISO9227 / <i>ASTM G85</i>, with incision during test duration (Appendix 4)</p> <p>Blistering quotation according to ISO 4628-2 (<i>ASTM D714</i>) after samples cooling and drying</p> <p>Degree of rusting according ISO 4628-3 (<i>ASTM D610</i>)</p> <p>Propagation of corrosion on the scribe according appendix 4</p>	<p>480 h for internal parts 960 h for external parts 1440 h for internal parts in sensitive areas</p> <p>Blistering: <i>Max quantity 3, max size 2 (≤ 3(S2)) Max quantity 2, max size 3 (≤2(S3))</i></p> <p>Scale of corrosion: Ri0 (no corrosion)</p> <p>Corrosion average width ≤ 3mm</p> <p><i>Blistering: max. Size 6 and few density max. Size 8 and max medium density</i></p> <p><i>Degree of rusting: Rating of 10 Corrosion average width ≤ 3mm</i></p>	<p>X</p>		<p>Steel Alu Stainless steel ferritic, Iron Casting</p>

7.4. VISUAL ACCEPTANCE CRITERIA

Whatever the case, the quality of the coating must ensure mechanical and chemical resistance and anti-corrosion properties, independently of aspect.

Any degradation, perforation of the topcoat layer, not complying with these criteria, must be corrected.

7.4.1. CONTROL CONDITIONS

Mean	Naked eye, with correction if necessary (neutral glass). Use of magnifying glass not allowed
Distance	Between 1 m (3 ft) and 1.5 m (4.5 ft) for external parts and 0.5 m (1.5 ft) for internal parts
Height	In front of part
Control	Static Special attention for external sides: Continuous movement with speed of a walking man, around 1 m/s (3 ft/s) at the level of station platform
Luminosity	400 Lux \pm 20%, measured 2 m (6 ft) above point of control

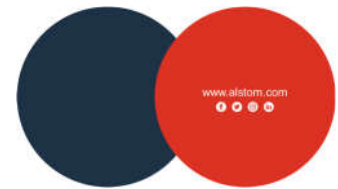

7.4.2. ACCEPTANCE CRITERIA ACCORDING TO PARTS LOCALIZATION

See Appendix 8 for details.

Defect type	External or internal visible (Localization: 1, 4, 7 et 8)	Internal not visible (Localization: 5 et 6)	External not visible (Localization: 2 et 3)	Axles, Anti roll bar, Spring (Localization 9 and 10)
Color difference, (cloudiness)	Not acceptable if confirmed by visual comparison with secondary standard	Slight difference acceptable by visual comparison with secondary standard and showing homogeneous appearance	Slight difference acceptable by visual comparison with secondary standard and showing homogeneous appearance	Slight difference acceptable by visual comparison with secondary standard and showing homogeneous appearance
Run Drop Powder accumulation	Not acceptable	Acceptable if Length < 50mm* (2 inches) Width < 7mm* (0.25 inch) Acceptable	Acceptable if Length < 50mm* (2 inches) Width < 7mm* (0.25 inch)	Acceptable if Length < 50mm* (2 inches) Width < 7mm* (0.25 inch)
Orange peel	Aesthetic appearance acceptable with the validation of the customer	Acceptable	Acceptable	Acceptable
Superficial Scratch	Acceptable if less than 30 mm (1.25 inches) * Visible: less than 30mm (1.25 inches) long* Non visible: acceptable	Acceptable	Acceptable	Acceptable
Impact – Choc	Not acceptable	Acceptable if surface less than 30mm ² * (1.25 inch sq)	Acceptable if surface less than 30mm ² * (1.25 inch sq)	Not acceptable
Pinholes – Miro bubbles – Dust and inclusions – Crater	Acceptable not more than 5 of one of these defects within a circle with Ø 25 mm (1 inch) (a circle of that type counts for 1 defect)	Acceptable	Acceptable if no gloss modification (visual inspection)	Acceptable if no gloss modification (visual inspection)
Overspray	Not acceptable	Acceptable	Acceptable	Not acceptable
Sanding marks/ putty aureole	Not acceptable	Acceptable	Acceptable	Not acceptable
Corrosion	Not acceptable	Not acceptable	Not acceptable	Not acceptable
Cracking –	Not acceptable	Not acceptable	Not acceptable	Not acceptable

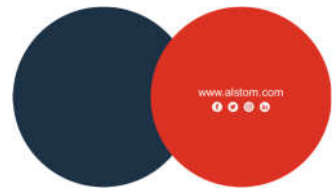

8. DRAWING / SPECIFICATION INDICATION

Following information will be included into drawing or technical specification:

- Part localization
- Color and gloss
- Reference to DTRF150608

Example:

Painting will be realized in compliance with standard specification DTRF 150608: Standard painting process.

Part localization: see §6.4

Color: RAL 7012 or reference to project specification

Gloss: ≥ 90 UB or reference to project specification

ASPxxx

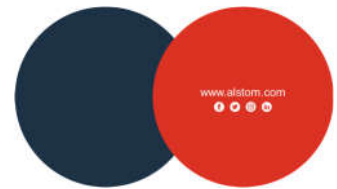

9. APPLICATOR DELIVERABLES SUMMARY

Documents to be submitted to Alstom approval are the following:

- Detailed **clause by clause analysis** of DTRF 150608, painting specification and drawing if any
- **Application document** (see example in Appendix 1)
- **Declaration form concerning very high alarming substances** (ENG FRM 001) except for products included in catalogue DTRF150611
- **Paint inspection sheet** (Appendix 2)
- **Validation test results** (see §7.3).
- **In case of chemical treatment**, if the applicator is not referenced and qualified by ALSTOM, it must present certification Qualicoat, GSB or BS, Qualisteelcoat or qualification dossier including:
 - Name and address of applicator
 - Detailed description of process (process and products)
 - Treatment type, spraying or immersion
 - Technical data sheets and safety data sheets for all products



10. APPENDICES

10.1. APPENDIX 1: PAINTING APPLICATION DOCUMENT TEMPLATE



doc_application_peint
ure_annexe1.xls

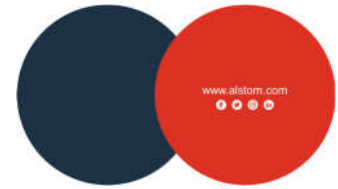

PAINTING APPLICATION DOCUMENT ACCORDING TO DTRF 150608						
NOTA		* Check the consideration of ALSTOM TRANSPORT requirements concerning painting processes and according DTRF 150608 * The supplier should detail each configuration Applicator / Material / Surface preparation / Painting system for the concerned project * The delivery of both detailed process flow chart and technical data sheets is greatly appreciated				
RANK 1 Supplier <i>(name and complete address)</i>						
RANK 2 Supplier <i>(name and complete address)</i>						
PAINTING Applicator <i>(name and complete address)</i>						
Painted parts	Description		Localisation <i>(according DTRF 150608-1)</i>		Part ID	
Material		Project		Available specifications		
Requirements and special constraints due to painted parts environment <i>(oil resistance, high temperatures, ...)</i>						
Surface preparation before painting	Degreasing					
	Mechanical treatment			Chemical treatment		
	Abrasive nature			Type		
	Final surface state <i>(Roughness, degree of care)</i>			Commercial references of products used		
Maximum duration between the end of surface preparation and the starting time of painting application (hours) Join arguments if this duration is upper than the requirement of DTRF 150608						
Painting system	Coating nature	Commercial references of products used <i>(supplier, designation, color and reference)</i>		Average applied thicknesses <i>(µm) and associated tolerances</i>	Application conditions <i>(T°C, RH%)</i>	Drying conditions <i>(temperature cycles)</i>
	Wash Primer					
	Primer					
	Putty					
	Intermediate					
	Topcoat					
	Basecoat					
	Clearcoat					
	Interior monocoat					
Exterior monocoat						
Powder primer						
Powder						
Duration between each application of the painting system (hours) Precise if grinding is used between 2 coating applications						
Validation and inspection controls	Type	Available control means and associated standards		Results and Tolerances	Control frequencies <i>(on parts , on indicator samples, ..)</i>	
	Viscosity					
	Thickness					
	Aspect					
	Color					
	Gloss					
	Cross cut behaviour					
	Salt Spray Test for validation					
	Cataplasma test for validation					
Rubout (powder)						
Duration and storage conditions before shipment Packaging details during transport						
Validation	REF and Edition	Applicator		Rank 1 supplier		
		Date and signature		Date and signature		



10.2. APPENDIX 2: INSPECTION SHEET



Inspection Sheet

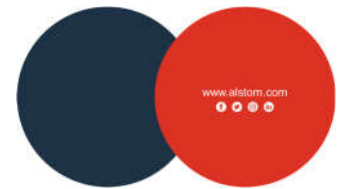

PAINTING INSPECTION SHEET ACCORDING TO DTRF 150608									
(Company name)					Certificat N°				
					BL Delivery :				
Applicator Company Name					Project :				
Supplier Name Rank 1									
General Reference Documents ex. : Technical Specification					Concerned identifiers :				
Specific Reference Documents					Nature of the piece				
Kind of support (material)					Beginning Date		End Date		Period of cycle
Kind of surface treatment		Mechanical treatment	Ra : 3,2 - 12,5 µm	Sa 2 1/2					
		Chemical treatment	Detail of process						
References product & supplier	Viscosity of application Cup N°	Batch N°	Expiry date	Thickness of layer staged on sample indicator representative of the production		T°C et HR during application according DTRF150608	Drying condition (T°C and period of cycle)	Date and Hour of application	
				Required	Measured (added)				
Primer Epoxy									
Putty									
Intermediate PU									
Topcoat PU									
Base coat									
Clearcoat PU									
Monocoat Interior									
Monocoat Exterior									
Primer Powder				Date last temperature chart of oven :					
Powder				Date last temperature chart of oven :					
Inspection operations			Requirements			Measured or noticed results			
Total thickness on production pieces			According to DTRF150608					µm	
Colour (on all parts)		Colour							
		According to secondary color sample N°							
Aspect (on all parts)			According to DTRF150608						
Gloss			Requierements and acceptance values					UB under 60°	
Cross cut test			Classe 0 à 1			Classe :			
Rub out (for powder only)			Rating 3 or 4						
VISA OF CONTROL									
Date									
Name of controler									
Observation :									
Visa									
FINAL DECISION				CONFORMITY <input type="checkbox"/>			NO CONFORMITY <input type="checkbox"/>		

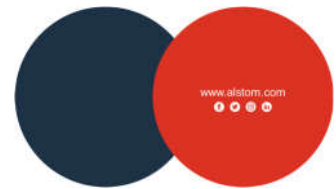

10.3. APPENDIX 3: THICKNESS CALCULATION PRINCIPLES

10.3.1. TOLERANCE TO THE SPECIFIED MEAN VALUE

The value must comply with a mean arithmetical thickness, so tolerance is applied to these values:

10.3.1.1. GENERAL CASE

Tolerance with respect to mean value is expressed as follow:

- If $x \leq 100 \mu\text{m}$ tolerance from $x_a = x - 10 \mu\text{m}$ to $x_b = x + 30 \mu\text{m}$
- If $x > 100 \mu\text{m}$ tolerance from $x_a = x - 20\%$ to $x_b = x + 20\%$

Furthermore, since calculation of an arithmetical mean value x relies on the use on points located between $x/2$ and $3x/2$, then following tolerance may be applied on unitary points:

- Minimum thickness, up to $x_{\min} = x_a/2$
- Maximum thickness, up to $x_{\max} = 3x_b/2$

10.3.1.2. SPECIFIC CASES

- For complex application areas, tolerance applicable applied to the mean value of paint products for high thickness is $\leq 100 \mu\text{m}$ must be increased and is expressed as follow:

$$x'_a = x - 20 \mu\text{m}$$

And

$$x'_b = x + 50 \mu\text{m}$$

For such complex areas, extra thickness can locally be accepted if it does not alter utilization properties of paint product.

Note: Term « complex application area » refers to a zone with changes in plane direction and for which at least one dimension is less than 10 cm.

- For wash primer or cathodic electrodeposition, tolerance with respect to mean value x is expressed as follow:

$$x''_a = x - 2 \mu\text{m}$$

And

$$x''_b = x + 2 \mu\text{m}$$

- For clearcoat, tolerance with respect to mean value x is expressed as follow:

$$x''_a = x - 10 \mu\text{m}$$

And

$$x''_b = x + 40 \mu\text{m}$$

And minimum points are accepted up to $x'_{\min} = 30 \mu\text{m}$.

10.3.1.3. ACCEPTANCE CRITERIA

- $x_a \leq X_{\text{measured}} \leq x_b$
- No point lower than x_{\min} or higher than x_{\max}

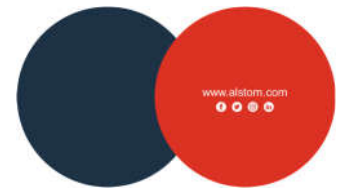

10.3.2. CASE OF IMPOSED MINIMUM: MINIMUM THICKNESS Z

Value must comply with minimum thickness z . It implies application of an average thickness higher than specified thickness (z).

Maximum thickness: $z_{\max} = 2z$.

Regarding minimum thickness, unitary points up to $0,8z$ are accepted.

10.3.3. CASE OF IMPOSED MAXIMUM: MAXIMUM THICKNESS Y

Value must comply with maximum thickness y . It implies application of an average thickness lower than specified thickness (y).

Regarding maximum thickness, unitary points up to $1.2y$ are accepted.

10.3.4. CASE OF STOPPER AND SIZING PUTTIES APPLIED WITH KNIFE

Maximum dry film thickness after rubbing down must be lower than or equal to 1 mm. However, for a few localized points, thickness may exceed 1 mm to offset major flatness defects.

10.3.5. WHAT TO DO IF ACCEPTANCE CRITERIA ARE NOT MET?

10.3.5.1. CASE OF SPECIFIED MEAN

Case n°1:

Measured average is $<$ than minimum tolerance, x_a :

Coat thickness is too small, additional paint layer must be applied on the substrate to bring thickness to the specified mean.

Case n°2:

$X_{\text{measured}} > x_a$, but some unitary points are lower than minimum value x_{mini} :

Application is not regular, a global application is not necessary.

Coat can still be accepted providing that its overall characteristics (appearance, adherence, cohesion,...) are not altered so that a satisfactory technical solution can be achieved.

When characteristics are not respected, a local application will be realized on areas with insufficient coat thickness.

Case n°3:

Measured mean x is $>$ than maximum tolerance x_b or there are unitary points greater than the maximum point x_{maxi} :

There is an excess of paint.

Coat acceptance depends on its overall characteristics verification so that a satisfactory technical solution can be achieved.

When characteristics are not respected, coat must be removed and applied again.

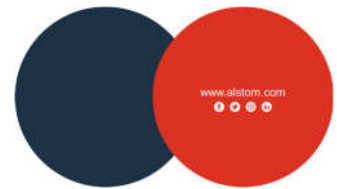

10.3.5.2. CASE OF IMPOSED MINIMUM

Case n°1:

The measured mean thickness is $<$ than the imposed minimum thickness z :

Thickness is not sufficient, additional paint layer must be applied on the substrate to bring thickness to the minimum imposed thickness.

Case n°2:

The measured mean thickness is $>$ than the imposed minimum thickness z , but some unitary points are lower than minimum value $0.8z$:

Application is not regular, a global application is not necessary.

Coat can still be accepted providing that its overall characteristics (appearance, adherence, cohesion,...) are not altered so that a satisfactory technical solution can be achieved.

When characteristics are not respected, a local application will be realized on areas with insufficient coat thickness.

Case n°3:

The measured mean thickness is $>$ than the imposed maximum thickness $z_{\max i}$:

There is an excess of paint.

Coat acceptance depends on its overall characteristics verification so that a satisfactory technical solution can be achieved.

When characteristics are not respected, coat must be removed and applied again.

10.3.5.3. CASE OF IMPOSED MAXIMUM

The measured mean thickness is $>$ than the imposed maximum thickness y :

Coat acceptance depends on its overall characteristics verification so that a satisfactory technical solution can be achieved.

When characteristics are not respected, coat must be removed and applied again.

10.4. APPENDIX 4: SALT SPRAY METHOD

The test is performed on 3 panels representative at iso-material configuration, size around: 150x100 mm. The back and the edges of the panel must be coated with the tested paint system or be protected to obtain a resistance to corrosion higher than the tested paint system. After drying and before exposure, surface of test pieces is incised up to the support using an ELCOMETER 1538/2 0.5 mm blade as per the below diagram

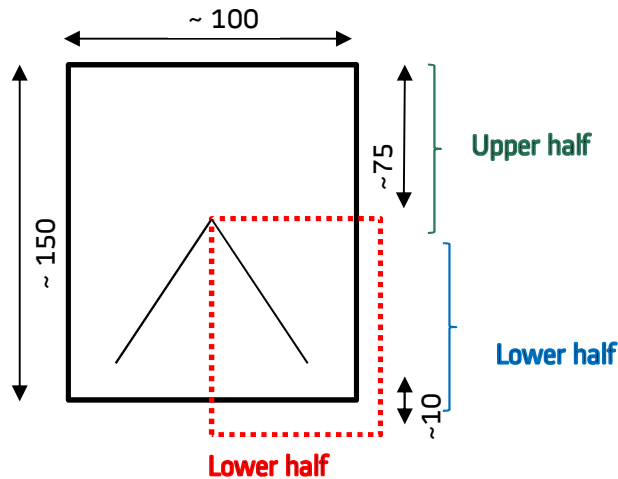

Fig 4.: Diagram of the panel (above dimensions are given in mm, approximate dimensions)

The test is performed without any stop. When test is completed, test pieces are washed under running water and dried by wiping. Degree of blistering and rusting is defined accordingly to ISO 4628 parts 2 and 3 on the upper half of test pieces. The film on the lower right half of the test piece is eliminated by chemical pickling using a product which does not affect oxidization. The extent of corrosion is observed on the pickled surface. The width of corrosion on the 3 test pieces is measured by taking the average width of the largest areas of corrosion at intervals of 10 mm all along the incision:

“

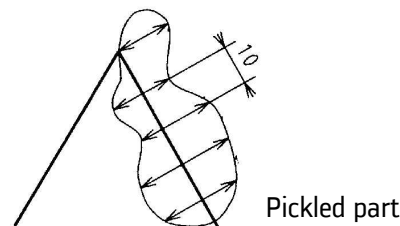
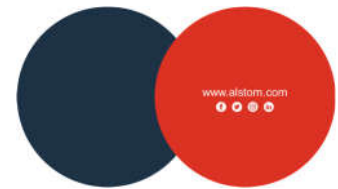

Figure 5: Corrosion areas
(Above dimension is given in mm \pm 1mm)

Surface of test pieces is then covered with transparent varnish.



10.5. APPENDIX 5: DEW POINT IDENTIFICATION

Dew point temperature (in °C or °F) is the temperature from which water in the air starts to condense by contact with a cold surface. The dew point is dependent on the air temperature and relative humidity.

In order to measure the dew point of a surface, the air temperature and relative humidity of the surrounding region is measured using specific equipment. Based on these parameters, the dew point of the surface can be obtained from the following tables for a pressure of 1013 mbar:

Air Temperature in Degrees Fahrenheit

Air Temp °F	% Relative Humidity																		
	100	95	90	85	80	75	70	65	60	55	50	45	40	35	30	25	20	15	10
110	110	108	106	104	102	100	98	95	93	90	87	84	80	76	72	65	60	51	41
105	105	103	101	99	97	95	93	91	88	85	83	80	76	72	67	62	55	47	37
100	100	99	97	95	93	91	89	86	84	81	78	75	71	67	63	58	52	44	32
95	95	93	92	90	88	86	84	81	79	76	73	70	67	63	59	54	48	40	32
90	90	88	87	85	83	81	79	76	74	71	68	65	62	59	54	49	43	36	32
85	85	83	81	80	78	76	74	72	69	67	64	61	58	54	50	45	38	32	
80	80	78	77	75	73	71	69	67	65	62	59	56	53	50	45	40	35	32	
75	75	73	72	70	68	66	64	62	60	58	55	52	49	45	41	36	32		
70	70	68	67	65	63	61	59	57	55	53	50	47	44	40	37	32			
65	65	63	62	60	59	57	55	53	50	48	45	42	40	36	32				
60	60	58	57	55	53	52	50	48	45	43	41	38	35	32					
55	55	53	52	50	49	47	45	43	40	38	36	33	32						
50	50	48	46	45	44	42	40	38	36	34	32								
45	45	43	42	40	39	37	35	33	32										
40	40	39	37	35	34	32													
35	35	34	32																
32	32																		

Dew Point Temperature at Atmospheric Pressure in Degrees Celsius

Air Temp °C	% Relative Humidity																		
	100	95	90	85	80	75	70	65	60	55	50	45	40	35	30	25	20	15	10
43	43	42	41	40	39	38	37	35	34	32	31	29	27	24	22	18	16	11	5
41	41	39	38	37	36	35	34	33	32	29	28	27	24	22	19	17	13	8	3
38	38	37	36	35	34	33	32	30	29	27	26	24	22	19	17	14	11	7	0
35	35	34	33	32	31	30	29	27	26	24	23	21	19	17	15	12	9	4	0
32	32	31	31	29	28	27	26	24	23	22	20	18	17	15	12	9	6	2	0
29	29	28	27	27	26	24	23	22	21	19	18	16	14	12	10	7	3	0	
27	27	26	25	24	23	22	21	19	18	17	15	13	12	10	7	4	2	0	
24	24	23	22	21	20	19	18	17	16	14	13	11	9	7	5	2	0		
21	21	20	19	18	17	16	15	14	13	12	10	8	7	4	3	0			
18	18	17	17	16	15	14	13	12	10	9	7	6	4	2	0				
16	16	14	14	13	12	11	10	9	7	6	5	3	2	0					
13	13	12	11	10	9	8	7	6	4	3	2	1	0						
10	10	9	8	7	7	6	4	3	2	1	0								
7	7	6	6	4	4	3	2	1	0										
4	4	4	3	2	1	0													
2	2	1	0																
0	0																		

The substrate/surface temperature is then measured in these conditions to ensure compliance to the below requirement.

Requirement: No coatings should be applied unless the surface temperature is a minimum of 5°F (or 3°C) above this dew point.

Example: If air temperature is 70°F and relative humidity is 65%, the dew point is 57°F. Hence, to apply paint under these conditions, the surface temperature should be maintained at least >62°F.

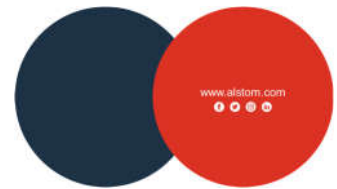

10.6. APPENDIX 6: SUBSTRATES PREPARATION

Oxidization classes:

CLASS A: Aluminum surface is free of oxidization and has a homogeneous appearance.
See reference picture 1

CLASS B: Aluminum surface is slightly oxidized.
See reference picture 2

CLASS C: Aluminum surface has wide areas clearly oxidized.
See reference picture 3

SA Level of cleanliness after sanding:

3 levels of cleanliness after sanding are defined (visual control):

Sa = 1: cleanliness after light sanding

Surface must be free of oil, grease, dirt, crusts or flakes slightly adhering, foreign objects

Sa = 2.5: cleanliness after intermediate sanding

Surface must be free of oil, grease, dirt, crusts or flakes slightly adhering, foreign objects. Remaining contamination marks must have the appearance of slight dirt.

Sa = 3: cleanliness after heavy sanding

Surface must be free of oil, grease, dirt, crusts or flakes slightly adhering, foreign objects. It must have a consistent metallic color.

Preparation classes:

Preparation classes are defined by description of surface appearance after cleaning operations with respect to photographic documentation [see § 6].

These reference pictures are the result from association of origin oxidization class before cleaning operations and from level sanding cleaning:

A – Sa 1 [picture 4]

B – Sa 1 [picture 7]

C – Sa 1 [picture 10]

A – Sa 2,5 [picture 5]

B – Sa 2,5 [picture 8]

C – Sa 2,5 [picture 11]

A – Sa 3 [picture 6]

B – Sa 3 [picture 9]

C – Sa 3 [picture 12]

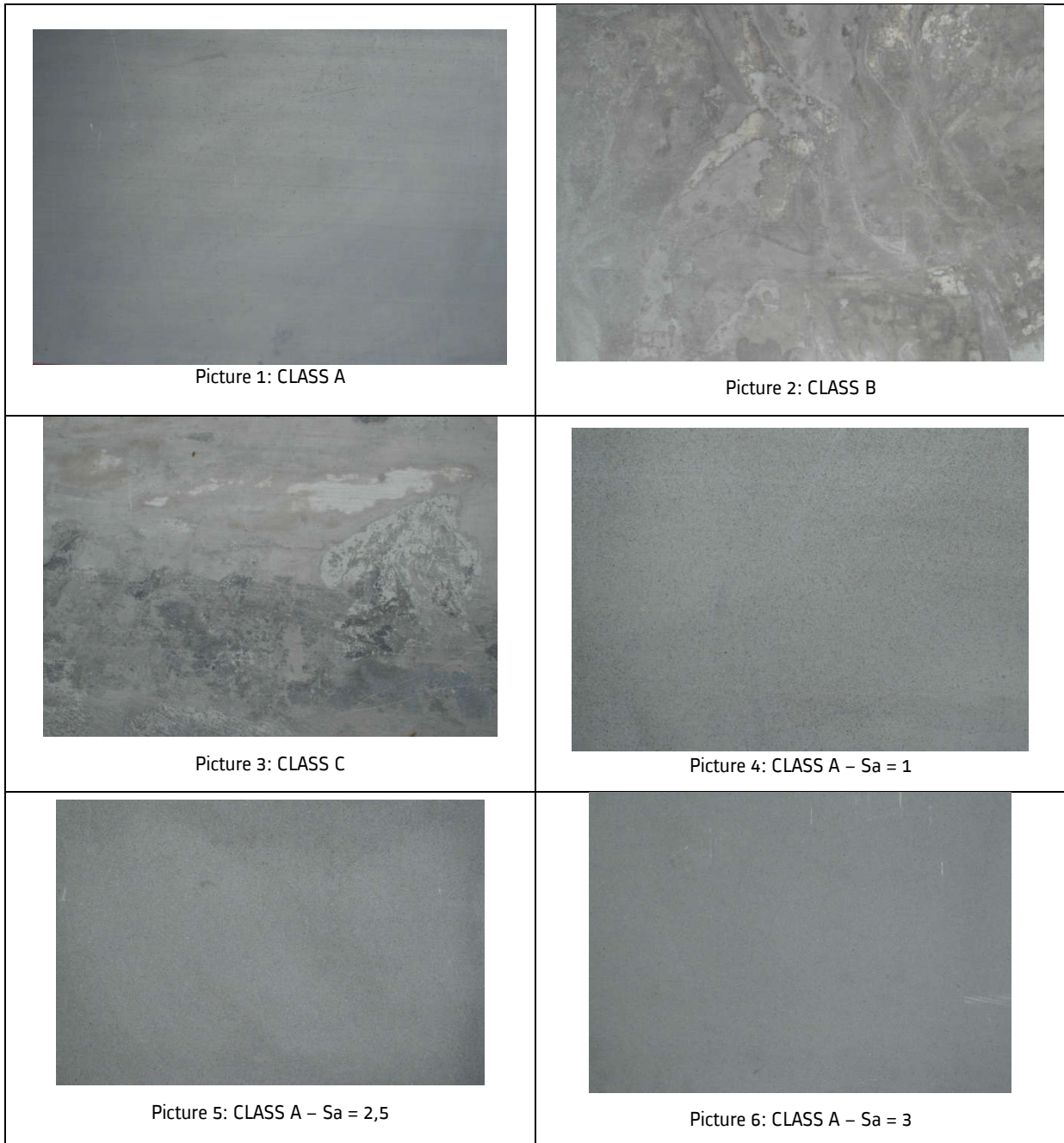



Picture 7: CLASS B – Sa = 1

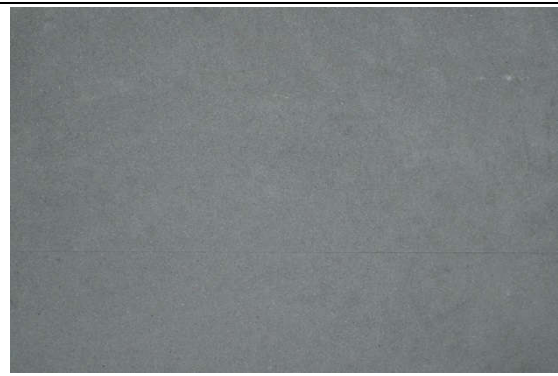

Picture 8: CLASS B – Sa = 2,5



Picture 9: CLASS B – Sa = 3

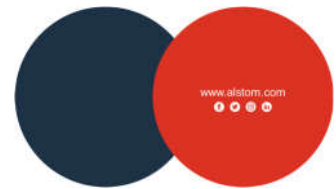

10.7. APPENDIX 7: CATAPLASM TEST

A) Required materials and equipment.

- 1) 4, 3"x6" coated test samples of appropriate substrate for each agreed upon buffer solution.
- 2) Clean cotton cloth 10" x 25", approx. 1oz
- 3) 12oz of DI or distilled water
- 4) Sealable heat proof plastic bags
- 5) Oven capable of sustaining 158 deg. F +-5 deg. F, for 7-14 days.
- 6) Applicable evaluation documents.
 - a) ASTM-D714, Evaluation of the degree of blistering
 - b) ASTM-D610, Evaluation of the degree of rusting
 - c) ASTM-D772, Evaluation of the degree of flaking
- 7) Protection the edges

B) Obtain 4 fully cured samples of the coating to be tested on the appropriate substrate for each of the environmental conditions to be tested.

C) Fold the four test samples for each environmental condition to be tested in a piece of clean cotton cloth taking care to ensure that there is complete surface contact between the cloth and test samples. Take care to ensure that there is no direct contact between the test samples, and that all of the test samples are facing up.

D) Place covered samples coating side up in a heat proof plastic bag and add 12oz. of the agreed upon buffer solution of distilled water taking care to remove as much air as possible before sealing the bag.

E) Place samples coating side up in a pre-heated oven capable of maintain a temperature of 158deg. F +- 5deg. F for the agreed upon length of the test. (7-days)







F) Remove samples, and as soon as the samples reach ambient air temperature remove from the plastic bag and gently wipe the surface dry with a clean, soft, absorbent cloth.

G) Evaluate the flat surface for blistering in accordance with ASTM-D714, Evaluation of the degree of blistering.

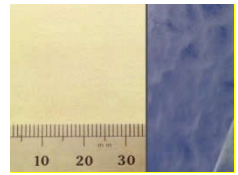
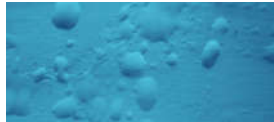
H) Evaluate the edges of the test plate and report the type of defect (blistering, rust, and flaking) in accordance with

- 1) ASTM-D714, Evaluation of the degree of blistering.
- 2) ASTM-D610, Evaluation of the degree of rusting.
- 3) ASTM-D772, Evaluation of the degree of flaking.

10.8. APPENDIX 8: DEFECT TYPES

Defect	Definition	Example
Over spray	Painted surface has uneven, matte appearance and is rough to the touch	
Bubbling/micro bubbling	Small bubbles trapped in the film, often with a hole at their summit	
Blistering	Blister into the paint film.	
Sagging	Local irregularities in the thickness of the film, caused by the downward slippage of a paint product when the substrate is in a vertical or inclined position.	
Defect of boundary between 2 colors	Boundary between 2 colors not regular	
Color difference	Different color visually perceptible	
Gloss difference	Different gloss compared to the standard (too gloss or too matt)	
Crazing	Creation of surface crackling with small meshes	
Wrinkling	The surface is covered in wavelets, the film remains generally soft	

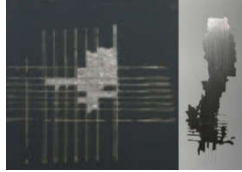
Scratch	Scratch on the paint film.	
Lack of adhesion	The film of paint peels off from the substrate through simple mechanical means or during a cross-cut test	
Mottling	Film has irregular hue and gloss (metallic paints)	
Sanding marks	Visible trace of sanding under the topcoat	
Orange peel	Poor film tension, undulation which resembles orange peel	
Pinholes	Presence in the film of small holes similar in appearance to pin-pricks	
Inclusions or dusts	Impurities of varying sizes trapped in the film	
Rejection	Formation on film of small circular craters which persist after drying and reveal the underlying coat or the metal	
Corrosion	Blistering irregularly shaped on the painted surface. Peeling of the paint with rust spots on the support (brown or carbon steel or white for aluminum)	

10.9. APPENDIX 9: DEFECT TYPES RELATED TO ASP

Care level related to (Assembly Surface Protection) in ai and bi areas.

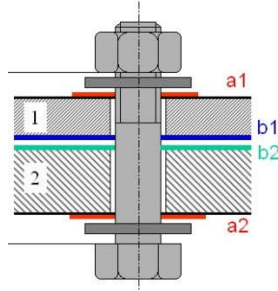

Defect	Example
Presence of paint in the screw area	
Dripping or burrsing contact areas of parts	

<p>Excess paint near holes</p>	
<p>Excess paint near on the edge of masking area</p>	<p>Sur les parties surfaces supérieures la peinture monocouche s'accumule sur le bord de l'adhésif de masquage.</p>
<p>Masking badly positioned</p>	
<p>Revision missing after assembly</p>	



10.10. APPENDIX 10: PPQ TEMPLATE



PPQtemplate.docx

RESULTS :

	Color	Gloss	Thickness (DFT μm)	Polymerisation test for powder paint	Adhesion	Salt spray	Cataplasm
Standard							
Evaluation method							
Requirements							
Panel 1	Picture			<i>Picture of the cotton wool and the tested surface after the test.</i>	<i>Picture of Cross lines before and after peel off the tape. Picture of the tape after peel off.</i>	<i>Picture before and after coating removal on creep.</i>	<i>Picture of adhesion test. Picture at the end of test.</i>
	Results						
Panel 2	Picture			<i>Picture of the cotton wool and the tested surface after the test.</i>	<i>Picture of Cross lines before and after peel off the tape. Picture of the tape after peel off.</i>	<i>Picture before and after coating removal on creep.</i>	<i>Picture of adhesion test. Picture at the end of test.</i>
	Results						
Panel 3	Picture			<i>Picture of the cotton wool and the tested surface after the test.</i>	<i>Picture of Cross lines before and after peel off the tape. Picture of the tape after peel off.</i>	<i>Picture before and after coating removal on creep.</i>	<i>Picture of adhesion test. Picture at the end of test.</i>
	Results						
Final result							

10.11. APPENDIX 11: ASP CODIFICATION BEFORE VERSION G

Protection	Technical solutions
ASPX	5, 6, 7
ASP00	Raw surfaces
ASP10	1, 3, 5, 6
ASP11	2, 4, 5, 6
ASP12	1, 3
ASP13	2, 4
ASP14	No protection or 1 or 3
ASP15	1, 3, 5
ASP16	2, 4, 5

Technical solutions are described below:

	Solution	Maximum thickness dry film
Liquid paint (water or solvent borne)	1	Average must be between 30 and 50 μm (1.25 and 2 mil) no unitary point should exceed 50 μm (2 mil) and no unitary point should be below 20 μm (0.75 mil)
	2	Average must be 50 μm (2 mil) with a minimum value of 40 μm (1.6 mil) and a maximum of 80 μm (3.2 mil), and no unitary point should exceed 100 μm (4 mil) or and no unitary point should be below 20 μm (0.75 mil)
Powder paint*	3	Average must be 70 μm (2.75 mil) with a minimum of 60 μm (2.4 mil) and a maximum of 100 μm (4 mil), and no unitary point should exceed 100 μm (4 mil) and no unitary point should be below 20 μm (0.75 mil)
	4	Average must be 70 μm (2.75 mil) with a minimum of 60 μm (2.4 mil) and a maximum of 100 μm (4 mil), and no unitary point should exceed 150 μm (6 mil) and no unitary point should be below 20 μm (0.75 mil)
E coat**	5	Average value provided by formulator should be respected as well as maximum and minimum values (maximum value should not exceed 30 μm (1.2 mil))
Metallic coating (e.g. electrolytic or lamellar)	6	
Liquid and powder	7	Standard thicknesses

(*) Polyester powder forbidden on mechanical interface because it is not hard enough to avoid a significant settlement of assemblies (loss of preload)

(**) Put on aluminum or carbon steel.