



**Project
S-Bahn Cologne**

**Loads Intermediate
Articulated Joint**

Document Reference DOC1001972860		Document Revision A	Revision Date 18/10/2024	ALSTOM
<i>Peter Fuchs</i> <small>Peter Fuchs (Oct 18, 2024 12:59 GMT+2)</small>		<i>Torsten Hinko</i> <small>Torsten Hinko (Oct 18, 2024 13:07 GMT+2)</small>		
<i>G. Kussatz-Klaass</i> <small>G. Kussatz-Klaass (Oct 18, 2024 13:01 GMT+2)</small>		<i>U. Radant</i>		
Peter Fuchs StM DE 18/10/2024	Georg Kussatz-Klaass StM DLE 18/10/2024	Torsten Hinko CbC DL 18/10/2024	Matthias Radant TAM 18/10/2024	
Author	Verifier 1	Verifier 2	Approver	
Confidentiality Category				
Public <input type="checkbox"/>	Restricted <input checked="" type="checkbox"/>	Confidential <input type="checkbox"/>	Secret <input type="checkbox"/>	

© ALSTOM SA 2024. All rights reserved. Reproduction, use or disclosure to third parties, without express written authorisation, is strictly prohibited.

CONTENTS

Purpose	5
Scope of Application	5
Responsibilities for the Execution of this Document	5
Section 1 – Abbreviations, Definitions and Applicable documents	6
1.1 Abbreviations	6
1.2 Definitions	6
1.3 References	7
Section 2 – General	8
2.1 Introduction	8
2.2 Train Configuration and Layout	8
2.3 Intermediate Articulation Joint Description	8
2.4 Bogie and Carbody Masses for Dimensioning	11
Section 3 – Crash Requirements	12
Section 4 – Loadcase Definitions	13
4.1 Accelerations	13
4.2 Extraordinary Loadcases	13
4.3 Extraordinary loadcase combinations	19
4.4 Fatigue loadcases	20
4.5 Fatigue Load Combinations	25
A – APPENDICES	27
A- 1 Longitudinal Joint Loads (MND500, 100% traction)	27
A- 2 Longitudinal Joint Loads (MND280, 100% traction)	27
A- 3 Longitudinal Joint Loads (MND500, 50% traction)	28
A- 4 Longitudinal Joint Loads (MND280, 50% traction)	28
A- 5 Longitudinal Joint Loads (MND280, Service braking)	29
A- 6 Longitudinal Joint Loads (MND280, Emergency braking)	29
A- 7 Longitudinal Joint Loads (MND500, Service braking)	30
A- 8 Longitudinal Joint Loads (MND500, Emergency braking)	30
A- 9 Vertical loads : Lifting with bogie attached	31

Tables List

Table 1: Revision History	4
Table 2: References	7
Table 3: Masses for dimensioning of inter-car joint [R6]	11
Table 4: Accelerations	13
Table 5: Lateral load at joint	15
Table 6: Extraordinary load combinations at articulation joint	20
Table 7: load collective for longitudinal fatigue loads for endurance limit approach (1E7 load cycles)	25
Table 8: Fatigue loadcase combinations ; ECOMBXXa : negative vertical loading ; ECOMBXXb : positive vertical loading	26

Figures List

Figure 1: Coordinate System	6
Figure 2: S-Bahn Cologne 11-car train configuration	8
Figure 3: S-Bahn Cologne train composition order	9
Figure 4: Forces at joint	10
Figure 5: Lateral load determination	15
Figure 6: Location of critical joint	16
Figure 7: interface loads ; 100% traction, MND500	16
Figure 8: interface loads ; 50% traction, MND500	17
Figure 9: interface loads ; emergency braking, MND500	17
Figure 10: interface loads ; 50% traction, MND500	18
Figure 11: re-railing : equilibrium of forces/moments	18
Figure 12: articulation joint loads, Lifting	19
Figure 13: interface loads ; 100% traction, MND280	22
Figure 14: interface loads ; 50% traction, MND280	23
Figure 15: interface loads ; emergency braking, MND280	24

REVISION HISTORY

Document Revision	Author	Revision Date	Page / Section / Paragraph	Comments
A	Peter Fuchs	18/10/2024	All	First issue

Table 1: Revision History

Purpose

The scope of this document is to describe the extraordinary and fatigue loads for the intermediate articulated joint of S-Bahn Cologne.

Scope of Application

This load specification is valid for the intermediate articulated joint between all S-Bahn Cologne cars in 9-car and 11-car configuration.

Responsibilities for the Execution of this Document

Accountable: This document is based on engineering instructions of the TDO structure mechanics. The MLE structure mechanics adapts the engineering instructions for the specific requirements of the project.

Responsible: MLE structure mechanics.

Key Contributors: Key contributors are the TDO structure mechanics and the bogies team.

Section 1 – Abbreviations, Definitions and Applicable documents

1.1 Abbreviations

- EW End car
- JMBOG..... Jacobs Motor Bogie
- LDG trailer bogie
- MB Magnetic Brake
- MBOG..... Motor Bogie
- MW Middle car
- TDG Motor bogie
- ZW Intermediate car

1.2 Definitions

The coordinate system is based on the EN 12663-1 [R1] and shown in Figure 1. The X-Axis of the vehicle is pointing in driving direction, the Y-Axis is the lateral and the Z-Axis the vertical one.

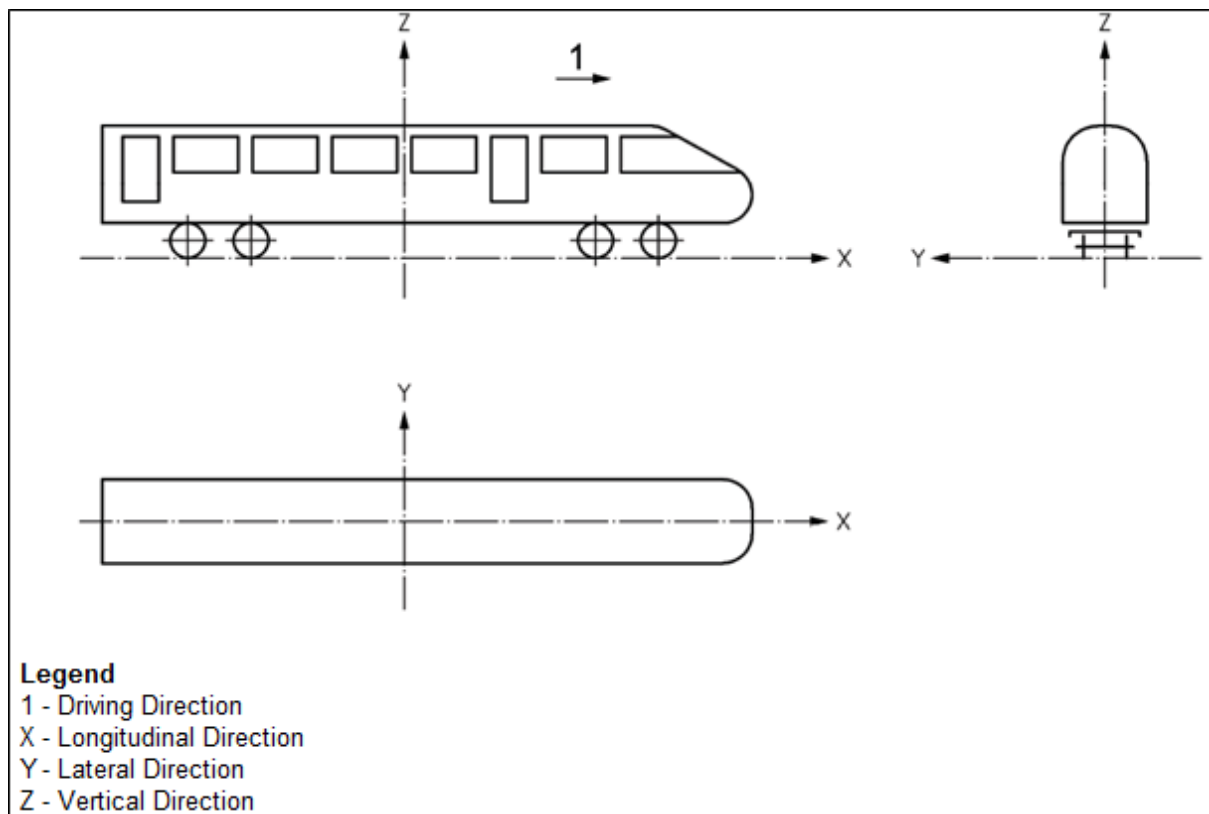

Figure 1: Coordinate System

1.3 References

	Title	Reference
[R1]	Railway applications – Structural requirements of railway vehicle bodies – Part 1: Locomotive and passenger rolling stock – German version	EN 12663-1: +A1 2014
[R2]	EN 13749 Railway applications - Wheelsets and bogies - Method of specifying the structural requirements of bogie frames	EN 13749:2024
[R3]	Customer specification S-Bahn Köln : 20100_FLV,_Anlage_1_Fahrzeuglastenheft_V7.pdf	
[R4]	Materials Mechanical Characteristics	DTRF150209 K1
[R5]	S-Bahn Cologne train layout 11 – car train	AFD0006109634
[R6]	S-Bahn Cologne weight report: SBK_weight_Report_Articulated_A10-1212_2024-05-21	
[R7]	Bogies for Cologne S-Bahn: Interface requirements bogie – vehicle	100703287 _
[R8]	Brake force summary Emergency braking SBK_A10_11Car_0ED_27062024_133944.xls	
[R9]	Brake force summary Service braking SBK_A10_11Car_100ED_08032024_160330.xls	

Table 2: References

Section 2 – General

2.1 Introduction

This specification describes the extraordinary and fatigue loads on the inter-car joints of S-Bahn Köln.

The accelerations for bogie and carbody masses and the resulting loads are defined in accordance with EN 12663-1[R1] and EN 13749[R2]. For Crash loadcases an increased longitudinal force is used, which corresponds to the crash absorber forces. The safety factors according EN 12663-1 shall be used.

The static and fatigue assessment of the following loadcases shall be performed according DTRF150209 [R4]. This includes the assessment approach, the material permissible and the safety factors of this Alstom standard. Deviations from this approach must be accepted by Alstom.

2.2 Train Configuration and Layout

The S-Bahn cologne trains will operate in a 9- and 11-car configuration.

The configuration and layout of the 11-car train is described in[R5] and Figure 2. In the 9-car train, both ZW-cars are omitted. The train consists of end-cars (EW), short (MW1, ZW) and long (MW2,3,4) middle cars. The train ends are supported by a conventional motor bogie, while Jacobs- trailer and motor bogies are located between the cars.

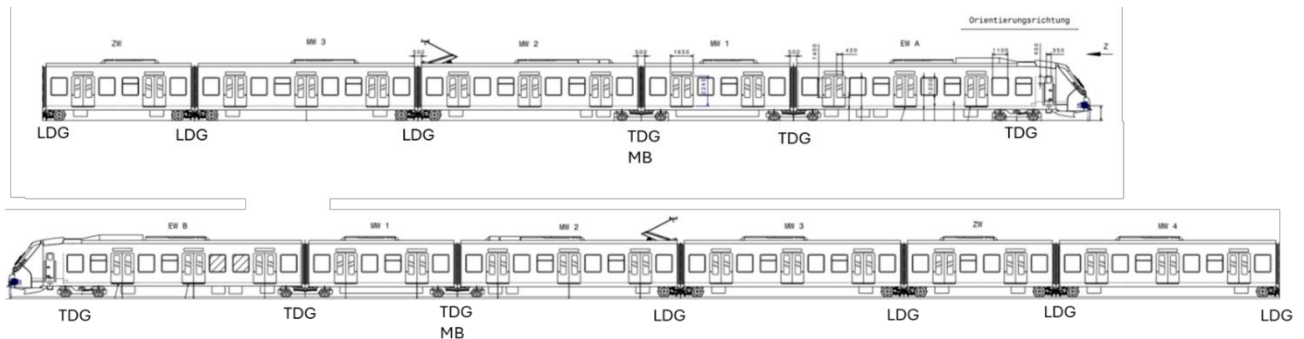
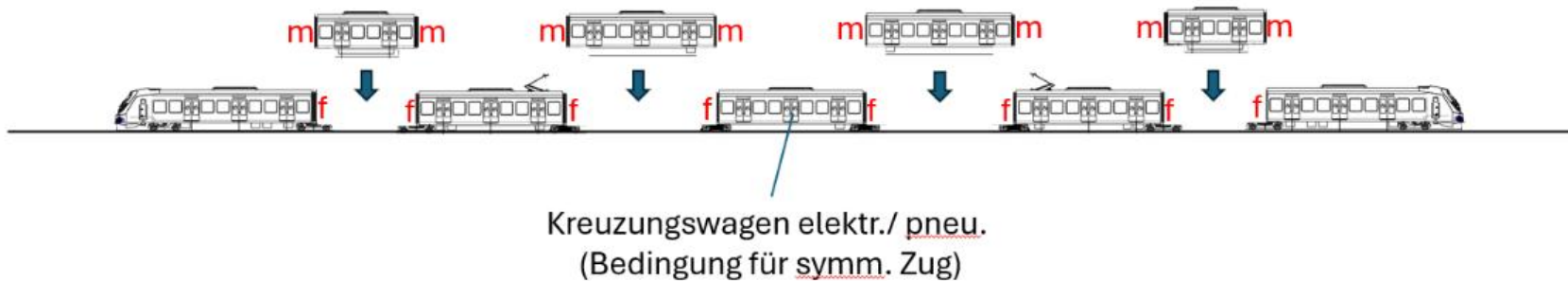

Figure 2: S-Bahn Cologne 11-car train configuration

2.3 Intermediate Articulation Joint Description

The intermediate articulation joint consists of two sides. In one side (female side, see Figure 3), the traction link to the bogie is integrated.

Aufsatzreihenfolge Kurzzug (A10)



Aufsatzreihenfolge Langzug (A10)

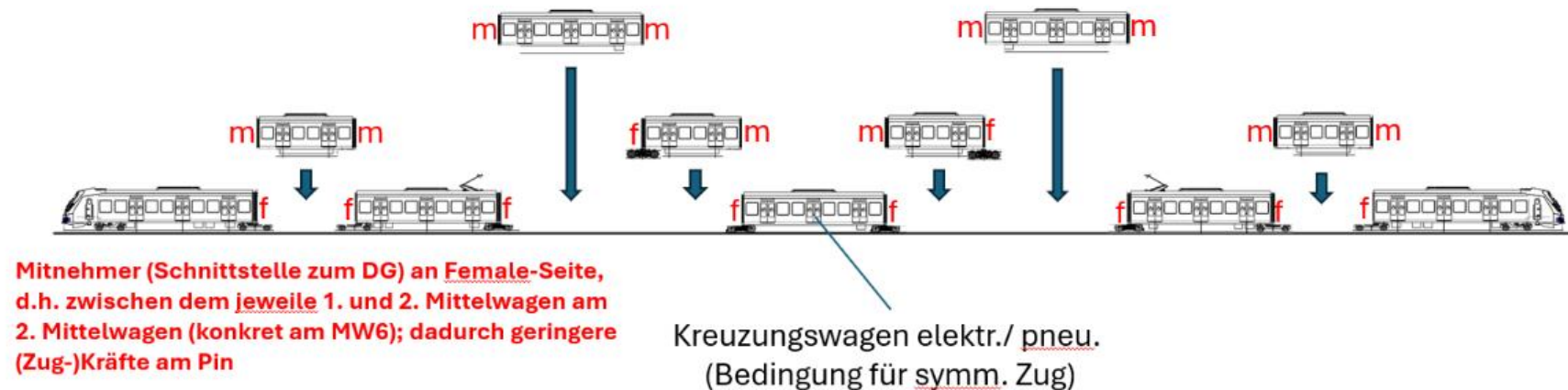

Figure 3: S-Bahn Cologne train composition order

The forces, acting on the joints are depicted in Figure 4.

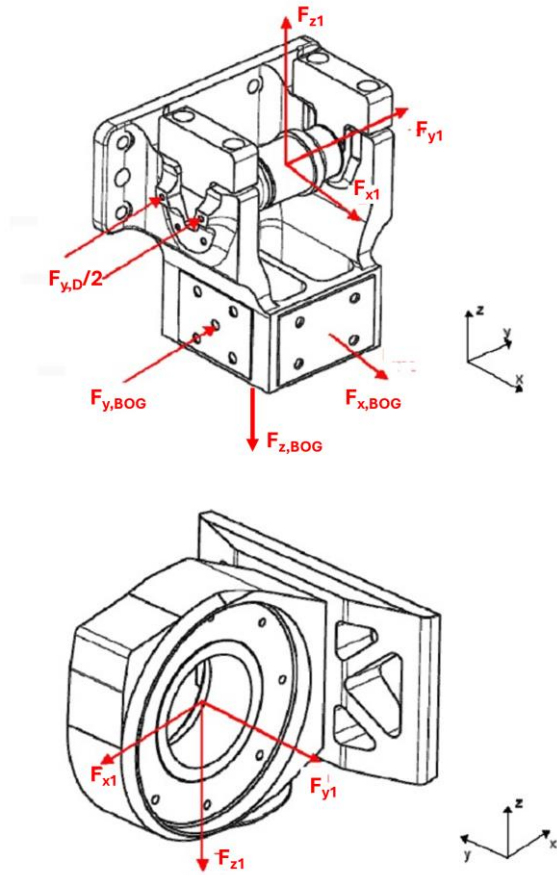

Figure 4: Forces at joint

2.4 Bogie and Carbody Masses for Dimensioning

Description	Mass	Comment
max. mass Jacobs motor bogie (m_{JMB})	9331 kg	
max. mass Jacobs trailer bogie (m_{JTB})	5030 kg	
max. axle load	19750 kg	includes the customer reserve
mass EWA carbody	40917 kg	MND280 condition; includes the customer reserve
mass MW1/MW7 carbody	27978 kg	MND280 condition; includes the customer reserve
mass MW2/MW6 carbody	27499 kg	MND280 condition; includes the customer reserve
mass MW3/MW5 carbody	25715 kg	MND280 condition; includes the customer reserve
mass MW4 carbody	26092 kg	MND280 condition; includes the customer reserve
mass MW-Z1/MW-Z2 carbody	18397 kg	MND280 condition; includes the customer reserve

Table 3: Masses for dimensioning of inter-car joint [R6]

Section 3 – Crash Requirements

A deformation unit is fitted to the intermediate articulation joint, which absorbs crash energy in two stages. Stage1 starts at 1600kN longitudinal load and Stage2 starts at 2600kN longitudinal load.

The proof load for the intermediate articulation joint is 1500kN in X-direction.

The deformable parts shall be guided in horizontal and vertical direction and the cars shall remain connected after the crash. To determine the safety margin in crash, the bogie shall be accelerated with $\pm 5g_X$. For this loadcase the ultimate limit shall not be exceeded and the functionality of the intermediate articulation joint shall remain. For this evaluation, the loadcases ECOMB03a/b and ECOMB04a/b (see Table 6) shall be modified accordingly.

Section 4 – Loadcase Definitions

For the evaluation of the intermediate articulation joint, load combinations of static loadcases and combinations of fatigue loadcases shall be considered.

4.1 Accelerations

The accelerations of EN 12663-1[R1] are considered for the evaluation of the intermediate articulation joint and the bogie connection:

Acceleration	Symbol	Value	Comment
Extraordinary accelerations			
Longitudinal Accel. X	a_x	$\pm 3g$	Acceleration for bogies according EN 12663-1
Lateral Accel. Y	a_y	$\pm 1g$	Acceleration for bogies according EN 12663-1
Braking X	$a_{x\max}$	$\pm 2.5m/s^2$	Emergency braking according EN 12663-1
Fatigue accelerations			
Traction/braking X	a_{xS}	$\pm 0.18g$	max. fatigue acceleration / deceleration
Lateral acceleration Y	a_{yS}	$\pm 0.15g$	max. fatigue acceleration according EN 12663-1
Vertical acceleration Z	a_{zS}	$(1\pm 0.15)g$	max. fatigue acceleration according EN 12663-1

Table 4: Accelerations

The acceleration due to gravity g is $-9.81m/s^2$.

The value of $\pm 0.18g$ in X for the traction/braking fatigue loadcase is the maximum deceleration value, the train can reach in the MND280 configuration with the use of the magnetic brake.

4.2 Extraordinary Loadcases

4.2.1 ELC01 - Vertical load

The maximum difference force of the secondary spring loads, acting on the joint, is between the MW4 with maximum load (MXD500) and the MWZ2 in load configuration MVD. According to EN12663-1 Annex B, this load shall be scaled with a factor of 1.3.

$$F_{z1} = 1.3g \cdot (m_{MW4_MXD500} - m_{MWZ2_MVD}) / 2 = 1.3 \cdot -9.81m/s^2 \cdot (16228kg - 5318kg) / 2 = -69.6 \text{ kN}$$

Depending on which side of the joint is connected to which car, the vertical difference force can have a positive or negative orientation.

ELC01a – negative vertical load; ELC 01b – positive vertical load

4.2.2 ELC02 – Maximum coupler tension

The maximum coupler tension force according EN 12663-1 is: $F_{x1}=1000$ kN.

4.2.3 ELC03 – Maximum coupler compression

The maximum coupler compression force according EN 12663-1 is: $F_{x1}=-1500$ kN.

4.2.4 ELC04 - Lateral forces at the intermediate articulation joint

a. Lateral limit load at bogie interface according Prud'homme (EN 13749 [R2]):

The Prud'homme force gives the maximum lateral wheel – rail forces, the rails can bear without lateral movement of the rails. This load is request in EN 12663-1 §6.5.1b. The maximum axle load of the train according [R6] is used for the calculation. It is calculated per axle:

$$F_{y,prud'homme}=10^4+(m_{axle_max} * g)/3=10000 \text{ N}+(19750 \text{ kg} * 9.81 \text{ m/s}^2)/3=67.9 \text{ kN per axle} = 135.8 \text{ kN per bogie.}$$

$$F_{y,Bog}=F_{y,prud'homme}=135.8 \text{ kN}$$

b. Lateral forces at bogie interface due to lateral accelerations (according Table 4) :

According EN12663-1 [R1], the connection between carbody and bogie needs to withstand the lateral acceleration of the bogie of $a_{y,impact}=\pm 1g$.

$$F_{y_Bog}=-a_{y,impact} * m_{JMB}=-9.81 \text{ m/s}^2 * 9331 \text{ kg} = 91.5 \text{ kN}$$

c. Lateral limit load according EN 12663-1 [R1] Annex B

The lateral load is determined according Figure 4:

b) Lateral load F_y determined as follows:

$$F_y = a_y p^2 m_1 + \frac{\dot{\omega} J_{zz}}{l}$$

where

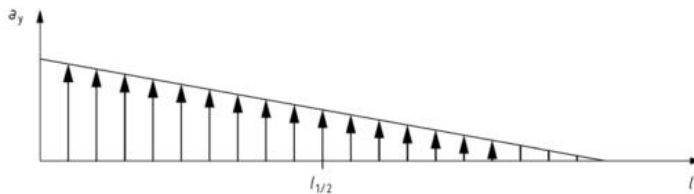

a) Example 1: Design with two articulations

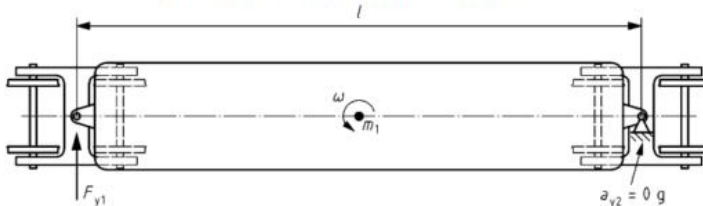

b) Example 2: Design with articulation and bogie

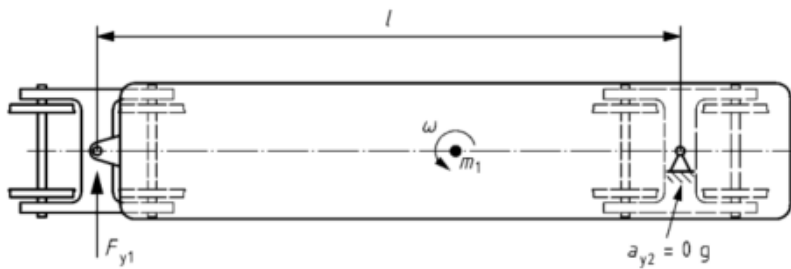

Figure 5: Lateral load determination

For S-Bahn Cologne, this leads to the following results :

Configurations	EW-B	MW1	MW2	MW3	MW-Z2	MW4
$M_{\text{running-order}}$ [kg]	30794	14372	16668	14883	10791	15132
l [mm]	16180	11020	16180	16180	11020	16180
x_{g1} [mm]	10665	5510	8090	8090	5510	8090
p	0.341	0.500	0.500	0.500	0.500	0.500
J_{zz} [kg.m ²]	926815	137016	409151	362579	131032	370716
a_y [m/s ²] = 1G	9.81	9.81	9.81	9.81	9.81	9.81
F_y [kN]	69.827	46.316	56.210	50.087	37.050	51.003
Weight acting on the articulation [kg]	7118	4721	5730	5106	3777	5199

Table 5: Lateral load at joint

The maximum lateral load on the articulation joint is: $F_y = 69.8\text{ kN}$

To consider the load on the intermediate articulation joint due to the maximum force of the lateral damper, acting in parallel, this force is applied additionally in the same load direction as worst case loadcase combination.

Until a detailed bogie interface load specification is available, it shall be assumed with:

$$F_{yD} = 10\text{ kN.}$$

4.2.5 ELC05 – Loads from longitudinal impact accelerations of the trailer bogie

The articulated intermediate joint shall be designed to work with trailer and motor bogies. Since the mass of the motor bogie is higher, ELC05 is not used.

4.2.6 ELC06 – Loads from longitudinal impact accelerations of the motor bogie

According EN 12663-1, the impact load on the Jacobs motor bogie is:

$$F_{x,Bog} = a_{x,impact} * m_{JMB} = 3 * 9.81\text{ m/s}^2 * 9331\text{ kg} = 274.6\text{ kN}$$

4.2.7 ELC07 – Loads from longitudinal accelerations

The longitudinal loads on the joint during service are defined by traction and braking loadcases. The maximum acceleration/deceleration for each loadcase is determined with the weight of the train in the corresponding weight condition (MXD500 for exceptional loadcases) and the sum of the traction or brake forces of all bogies. The three bogies on both ends of the train are motor bogies (see Figure 2), the rest is trailer bogies. The maximum traction force is $F_{tract} = 35\text{ kN}$ per axle and $F_{tract,bog} = 70\text{ kN}$ per bogie. The carbody and bogie masses are defined in [R6].

For a train with *i* cars, *i*-1 intermediate articulation joints are used and *i*+1 bogies.

A 11 car train, which is more critical than a 9 car train has 10 intermediate articulation joints and 12 bogies.

Since the value of the traction/brake forces differs between the bogies, the longitudinal forces need to be calculated for each joint separately. These calculations are given in detail in appendix A- 1 to A- 8.

For the case: Traction, 100% of bogies working, loading condition MND500 the detail calculations to derive the results from A- 1 are shown exemplarily:

The maximum acceleration of the train is:

$$a_{tract,100\%} = F_{tract,100\%} / m_{train11, MND280}$$

$$a_{tract,100\%} = 6 \times 70 \text{ kN} / 438901 \text{ kg} = 0.957 \text{ m/s}^2 = 0.0975g$$

The most critical intermediate articulated joint is between the cars MW7 and MW6 (mirror symmetrical MW1-MW2), which is depicted in Figure 6.

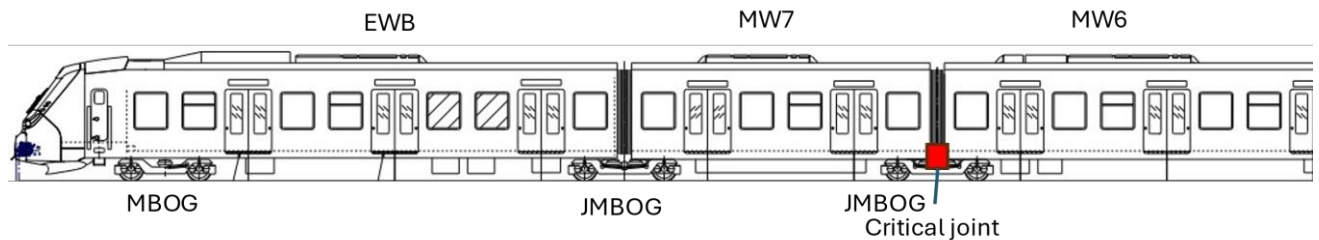

Figure 6: Location of critical joint

For the calculation of the joint forces, the forces and inertias on one side of the joint are summed up.

$$F_{x,tract100\%} = F_{tract,100\%} - (m_{EWB, MND500} + m_{MW7, MND500} + m_{MBOG} + 2 \cdot m_{JMBOG}) \cdot a_{tract,100\%}$$

$$F_{x,tract100\%} = 140 \text{ kN} - (46557 \text{ kg} + 26500 \text{ kg} + 8542 \text{ kg} + 8862 \text{ kg}) \cdot 0.957 \text{ m/s}^2 = 53.4 \text{ kN}$$

The maximum traction force on the bogie pin is:

$$F_{x1, Bog} = F_{tract, MBOG} - a_{tract} \cdot m_{MBOG} = 70 \text{ kN} - 0.957 \text{ m/s}^2 \cdot 9331 \text{ kg} = 61.07 \text{ kN}$$

With the mounting direction of the joint as given in Figure 3, the following maximum interface forces shall be applied:

Traction; 100% MW7-MW6
MND500

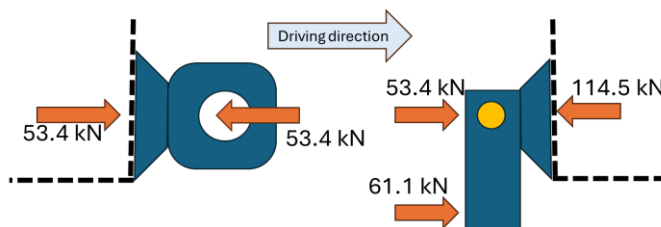

Figure 7: interface loads ; 100% traction, MND500

The arrows show the direction of the forces.

a. maximum longitudinal loads at joint:

The calculations in appendix A- 1 to A- 8 show, that the maximum longitudinal loads during operation are occurring with 50% traction and the maximum passenger mass (loading condition MND500) (see Appendix A- 3).

The maximum loads at the articulation joint are depicted in Figure 8.

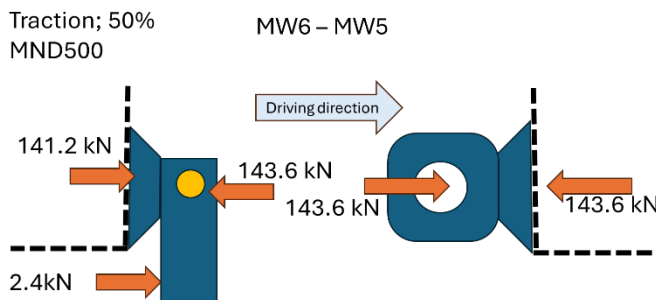

Figure 8: interface loads ; 50% traction, MND500

b. maximum longitudinal loads at centre pin:

The maximum longitudinal loads at centre pin are acting during emergency braking at the bogie between MW7 and MW6, where magnetic brakes are installed (see A- 8).

The loads for this case are depicted in Figure 9.

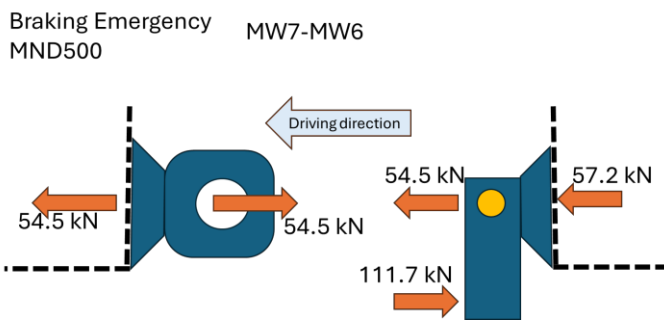

Figure 9: interface loads ; emergency braking, MND500

c. maximum longitudinal loads at carbody interface:

The calculations in appendix A- 1 to A- 8 show, that the maximum longitudinal loads at the carbody interface are occurring with 50% traction and the maximum passenger mass (loading condition MND500) (see Appendix A- 3).

The force split up is depicted in Figure 10.

Traction; 50%
MND500

MW7-MW6

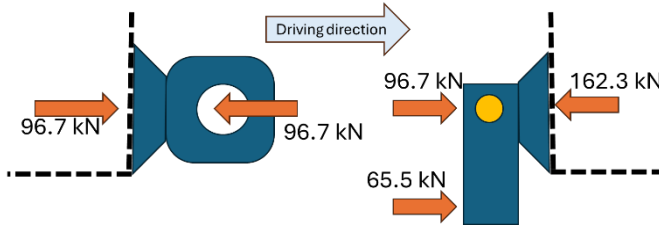

Figure 10: interface loads ; 50% traction, MND500

4.2.8 ELC08 - Lifting

The lifting loadcase on one car end is loading the intermediate articulation joint in Z-direction, since the car end of the adjacent car and the bogie must be lifted up, too. Furthermore the load must be scaled with a factor 1.1 according to EN 12663-1.

The vertical load is determined, considering a static equilibrium of the re-railed vehicle (see Figure 11) and the formula:

$$F^* * d_1 = m * g * (d_1 - x_{g1}) + m_b * g * (d_1 - e_1)$$

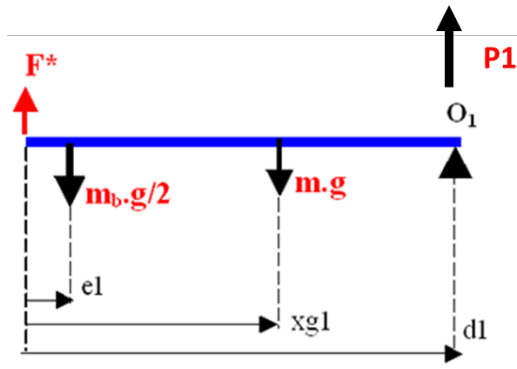

Figure 11: re-railling : equilibrium of forces/moments

- F*: vertical load, acting on the articulation
- P1: reaction load on secondary suspension of other bogie of considered vehicle
- m*g: vertical load acting on the vehicle due to carbody mass
- m_b*g: vertical load from hanging bogie
- e₁: distance between articulation and Jacobs secondary suspension
- x_{g1}: distance between the articulation and the centre of gravity of the vehicle
- d₁: distance between articulation and the secondary suspension of the bogie

The maximum load on the joint due to lifting is for the case: MW1 is lifted, a partial mass of the end car EW and motor bogie mass are connected over the joint (see A- 9).

The corresponding loads at the joint are depicted in Figure 12.

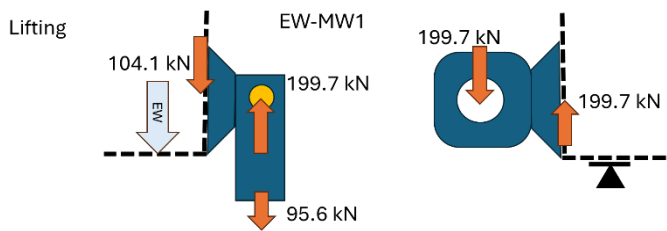

Figure 12: articulation joint loads, Lifting

4.3 Extraordinary loadcase combinations

According to EN 12663-1, the longitudinal compressive and tensile load cases shall be combined with the maximum vertical loads without scaling factors.

For the dimensioning of the intermediated articulated joint a longitudinal acceleration of $a_x = \pm 3g$ of the motor bogie is combined with the longitudinal coupler loads (ECOMB01-ECOMB04).

For the assessment of the margin of safety in case of crash, the bogie shall be loaded with a longitudinal acceleration of $a_x = \pm 5g$ against failure. The deformations shall be limited enough to ensure the functionality of the joint. For these investigations, ECOMB03 and ECOMB04 shall be adjusted.

For the extraordinary loads due to operation, traction with 50% traction power, the maximum lateral load due to lateral acceleration of the bogie and the maximum differential load as vertical load on the joint are superimposed (ECOMB05-08).

If there are additional loads due to pretension loads from the bolted assembly of the joint, they shall be considered in the load combinations, too.

The joint shall withstand the following load combinations:

Load-case	F _{x1}	F _{y1}	F _{z1}	F _{x,BOG}	F _{y,BOG}	F _{z,BOG}	F _{y,D}	Description of the Loadcase combination
ECOMB	[kN]	[kN]	[kN]	[kN]	[kN]	[kN]	[kN]	
01a 01b	1000		69.6 -69.6					ECOMB01a/b=ELC01a/b + ELC02 F _{x1} = 1000 kN Coupler Tension +F _{Z1max} (maximum difference load of joint)
02a 02b	1000		69.6 -69.6					ECOMB02a/b=ELC01a/b + ELC02 F _{x1} = 1000 kN Coupler Tension +F _{Z1max} (maximum difference load of joint)
03a 03b	-1500		69.6 -69.6	274.6				ECOMB03a/b=ELC01a/b + ELC03 + ELC06 F _{x1} = 1500 kN Coupler Compression

								+F _{Z1max} (maximum difference load of joint) +F _{x,DG} = -3g* bogie mass
04a 04b	-1500		69.6 -69.6	-274.6				ECOMB04a/b=ELC01a/b + ELC03 - ELC06 F _{x1} = 1500 kN Coupler Compression +F _{Z1max} (maximum difference load of joint) -F _{x,DG} = 3g* bogie mass
05a 05b	143.6	69.8	69.6 -69.6	-2.4	-135.8	10		ECOMB05a/b=ELC01a/b + ELC07a + ELC04 Prud'hommes Limit +F _{y1} -F _{yDG} -F _{yD} +Traction 50% F _{x1} +F _{x,BOG} +F _{Z1max} (maximum difference load of joint)
06a 06b	54.5	-69.8	69.6 -69.6	-111.7	135.8	-10		ECOMB06a/b=ELC01a/b + ELC07b + ELC04 Prud'hommes Limit -F _{y1} +F _{yDG} -F _{yD} +EmergBrake500 F _{x1} -F _{x,BOG} +F _{Z1max} (maximum difference load of joint)
07a 07b	96.7	-69.8	69.6 -69.6	65.5	135.8	10		ECOMB07a/b=ELC01a/b + ELC07c + ELC04 Prud'hommes Limit +F _{y1} -F _{yDG} -F _{yD} +Traction 50% F _{x1} +F _{x,BOG} +F _{Z1max} (maximum difference load of joint)
11a 11b			199.7 -104.1				-95.6	ECOMB11a/b=ELC08a/b Lifting at MW1 with motor bogie and half of Mass MW2 attached F _{Z1} =1.1g*(vertical load from carbody + m _{JMBOG})

Table 6: Extraordinary load combinations at articulation joint

4.4 Fatigue loadcases

The fatigue loads are based on the assumption, that all of the carbodies are loaded with a similar loading condition – for the following evaluation the weight condition MND280 is used for all carbodies.

As long as not described differently in the loadcase itself, each loadcase shall be evaluated as endurance limit loadcase (1E7 load cycles).

4.4.1 FLC01 – vertical fatigue load of intermediate articulation joint Fz1

The maximum vertical fatigue load is the maximum difference between the secondary spring loads of the two adjacent cars (MW₄ – MW-Z2):

$$F_{z1_stat} = g * (m_{MW-Z2, MND280} - m_{MW4, MND280}) / 2$$

$$F_{z1_stat} = -9.81 \text{ m/s}^2 * (12728 \text{ kg} - 8756 \text{ kg}) / 2 = 19.5 \text{ kN}$$

$$F_{z1_dyn} = \pm 0.15 * F_{z1_stat} = \pm 2.9 \text{ kN}$$

FLC01u: $F_{z1_max} = 1.15 * F_{z1_stat} = 22.4 \text{ kN}$

FLC01l: $F_{z1_min} = 0.85 * F_{z1_stat} = 16.6 \text{ kN}$

Depending on which side of the joint is connected to which car, the vertical difference force can have a positive or negative orientation. The joints are assembled according to a defined procedure and keep their position and orientation unchanged over the whole lifetime. Since the vertical fatigue difference load never occurs as an alternating load but is always defined by the heavier car end, two separate sets of load combinations (Group A / Group B) are defined in Table 8.

4.4.2 FLC02/FLC03 - Lateral fatigue loads at intermediate articulation joint

The loading scenarios FLC02 and FLC03 are used in fatigue load combinations by superposition with traction/braking and vertical fatigue loads.

FLC02 – lateral load due to lateral acceleration of both carbodies

Both carbodies are accelerated in lateral direction according to EN 12663-1. The resulting lateral force is transmitted by the elastic bump stop of the joint and the secondary springs. The bogie between EWB and MW7 (mirror symmetric MW1 and EWA) has the highest secondary spring load, which results in the most critical lateral fatigue loads:

$$F_{y,B0G} = a_{y,fat} * (m_{EWB,secspring,MND280} + m_{MW7,secspring,MND280}) - 4 * F_{y,airspring} = \quad \text{with } 4 * F_{y,airspring} = 15 \text{ kN}$$

$$F_{y,B0G} = 0.15 * g * (14376 \text{ kg} + 11141 \text{ kg}) - 15 \text{ kN} = 22.5 \text{ kN}$$

The critical lateral load on the inter-car joint is defined by the heavier of both cars:

$$F_{y1} = F_{y,B0G} * [m_{EWB,secspring,MND280} / (m_{EWB,secspring,MND280} + m_{MW7,secspring,MND280})]$$

$$F_{y1} = 22.5 \text{ kN} * (14376 \text{ kg} / (14376 \text{ kg} + 11141 \text{ kg})) = 12.7 \text{ kN}$$

FLC02u: $F_{y1_max} = 12.7 \text{ kN}; F_{y,B0G} = -22.5 \text{ kN}$

FLC02l: $F_{y1_min} = -12.7 \text{ kN}; F_{y,B0G} = 22.5 \text{ kN}$

FLC03 – lateral load at joint due to carbody movement in opposite directions

Two adjacent cars are accelerated in opposite directions so that the lateral load is transmitted only by the intermediate articulation joint (lateral bump stop of bogie not acting).

The intermediated articulated joint between MW6 and MW5 is the most critical one, because the lower secondary spring force of both adjacent bogies is the highest in the train.

$$F_{y1} = a_{y,fat} * (m_{MW5,secspring,MND280})$$

$$F_{y1} = 0.15 * g * 12994 \text{ kg} = 19.1 \text{ kN}$$

$$F_{y,B0G} = a_{y,fat} * (m_{MW6,secspring,MND280} - m_{MW5,secspring,MND280})$$

$$F_{y,B0G} = 0.15 * g * (13431 \text{ kg} - 12994 \text{ kg}) = 0.6 \text{ kN}$$

The fatigue load on the lateral damper is applied as counter load.

Fatigue lateral damper load: $F_{yD} = \text{TBD}$

FLC03u: $F_{y1_max} = 19.1 \text{ kN}; F_{y,B0G} = 0.6 \text{ kN}; F_{yD} = \text{TBD}$

FLC03l: $F_{y1_min} = -19.1 \text{ kN}; F_{y,B0G} = -0.6 \text{ kN}; F_{yD} = \text{TBD}$

4.4.3 FLC04 - Fatigue loads at the intermediate articulation joint due to traction/braking

The longitudinal fatigue loads on the joint are defined by traction and braking loadcases. The maximum fatigue acceleration/deceleration is determined with the weight of the train in MND280 condition and the sum of the traction or brake forces of all bogies. Since the value of the traction/brake forces differs between the bogies, the longitudinal forces need to be calculated for each joint separately.

For a train with i cars, $i-1$ intermediate articulation joints are used and $i+1$ bogies.

A 11 car train, which is more critical than a 9 car train has 10 intermediate articulation joints and 12 bogies.

a. fatigue loads from acceleration with 100% traction power

The joint forces due to this scenario are given in Appendix A– 2. The articulations joint with the highest loads are between EWB and MW7 and MW7 and MW6. This scenario is the main scenario for the fatigue evaluation of the articulation joint.

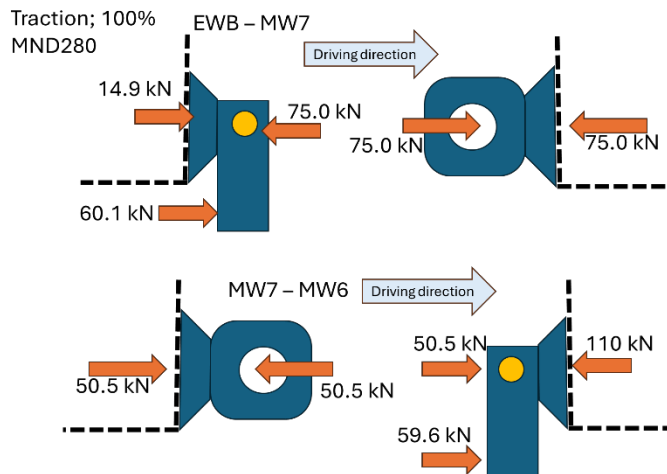

Figure 13: interface loads ; 100% traction, MND280

Since the train can run in both directions, the force on the joint can act in both directions.

EWB – MW7:

FLC04au: $F_{x,tract100,min} = +75.0 \text{ kN}$, $F_{x,MB0G,tract} = -60.1 \text{ kN}$

FLC04al: $F_{x,tract100,max} = -75.0 \text{ kN}$, $F_{x,MB0G,tract} = +60.1 \text{ kN}$

MW7 – MW6:

FLC04au: $F_{x,tract100,min} = +50.5 \text{ kN}$, $F_{x,MB0G,tract} = +59.6 \text{ kN}$

FLC04al: $F_{x,tract100,max} = -50.5 \text{ kN}$, $F_{x,MB0G,tract} = -59.6 \text{ kN}$

b. fatigue loads from acceleration with 50% traction power

According to the customer specification, the train shall be able to remain in operation with the loss of 50% of traction power. The most critical loadcase is if all motor bogies on one side of the train are failing and the train is powered only from the bogies on the opposite side.

The joint forces due to this scenario are given in Appendix A– 4. The loads are derived for the highest loaded articulation joints of FLC04a

The forces at the articulation joint are shown in Figure 14.

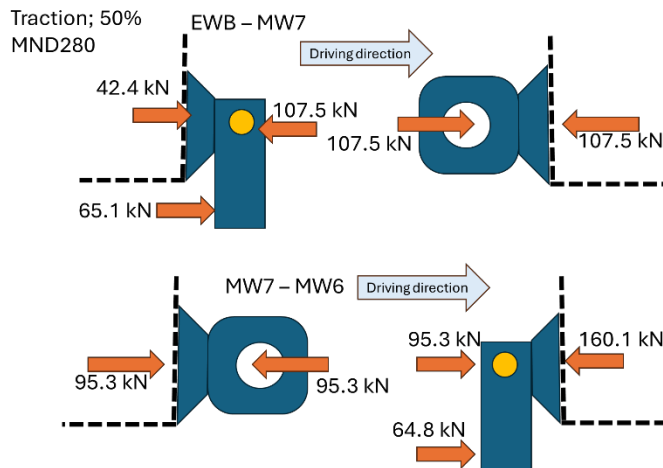

Figure 14: interface loads ; 50% traction, MND280

EWB – MW7:

FLC04bu: $F_{x,tract100,min} = +107.5 \text{ kN}$, $F_{x,MB0G,tract} = -65.1 \text{ kN}$

FLC04bl: $F_{x,tract100,max} = -107.5 \text{ kN}$, $F_{x,MB0G,tract} = +65.1 \text{ kN}$

MW7 – MW6:

FLC04bu: $F_{x,tract100,min} = +95.3 \text{ kN}$, $F_{x,MB0G,tract} = +64.8 \text{ kN}$

FLC04bl: $F_{x,tract100,max} = -95.3 \text{ kN}$, $F_{x,MB0G,tract} = -64.8 \text{ kN}$

The occurrence of this kind of loadcase is quite rare. The Alstom return of experience from similar trains is an occurrence of once per year. With a vehicle lifetime of 34 years and a maximum of 60 stations for tour and detour this sums up to a number of load cycles of:

$$n_{tract50\%} = 1 \text{ occurrence/year} * 34 \text{ year} * 60 \text{ (stations)} = 2040 \text{ cycles.}$$

To be conservative the loadcase shall be considered with **n = 5000 cycles**.

c. fatigue loads from emergency breaking

The loads on the intermediate articulation joint from service breaking are lower than then loads due to acceleration, since the break forces are more evenly distributed over the train.

The fatigue loads from emergency breaking are not covered by the traction loadcases, since the magnetic brake on the 3rd and 9th bogie leads to high forces at the traction pin.

The calculation of the load is given in Appendix A– 6. The forces on the articulation joint are shown in Figure 15.

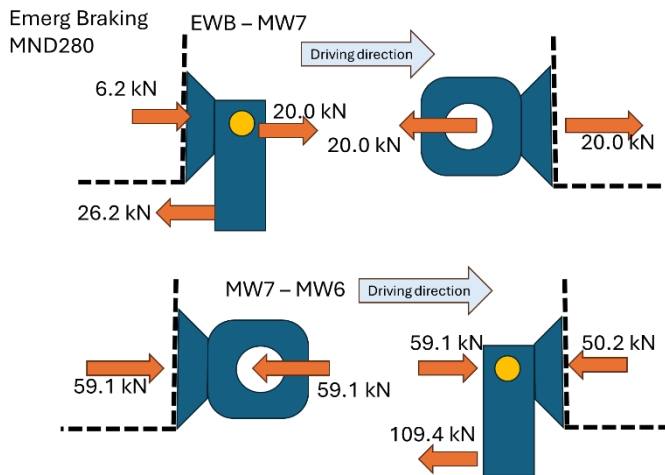

Figure 15: interface loads ; emergency braking, MND280

E WB – MW7:

FLC04cu: $F_{x,tract100\%,min} = +20.0 \text{ kN}$, $F_{x,MBOG,tract} = -26.2 \text{ kN}$

FLC04cl: $F_{x,tract100\%,max} = -20.0 \text{ kN}$, $F_{x,MBOG,tract} = +26.2 \text{ kN}$

MW7 – MW6:

FLC04cu: $F_{x,tract100\%,min} = +59.1 \text{ kN}$, $F_{x,MBOG,tract} = -109.4 \text{ kN}$

FLC04cl: $F_{x,tract100\%,max} = -59.1 \text{ kN}$, $F_{x,MBOG,tract} = +109.4 \text{ kN}$

The occurrence of this kind of loadcase is quite rare. Although the Alstom return of experience from similar trains is an occurrence of once per week, an occurrence of once per day is assumed as conservative approach.

With a vehicle lifetime of 34 years and 365 occurrences per year, this sums up to a number of load cycles of:

$$n_{\text{emerg_break}} = 1 \text{ occurrence/day} * 34 \text{ year} = 365 * 34 = \mathbf{12410 \text{ cycles}}$$

d. load collective for longitudinal loads

The load collective for the longitudinal fatigue loads consists of the loadcases and their corresponding number of load cycles, given in Table 7. The number of cycles for the 100% traction loadcase as the normal operation case is filled up, so that the overall number of load cycles in the collective is 10 million load cycles. The damage equivalent load for endurance limit evaluation is given for Wohler curve slopes $m=5$ and $m=7$.

Scenario		EWB – MW7		MW7 – MW6		No. of cycles
		F _{x1} [kN]	F _{x,BOG} [kN]	F _{x1} [kN]	F _{x,BOG} [kN]	
50% Traction	Upper	+107.5	-65.1	+95.3	+64.8	5000
	Lower	-107.5	+65.1	-95.3	-64.8	
Emergency braking	Upper	+20.0	-26.2	+59.1	-109.4	12410
	Lower	-20.0	-26.2	-59.1	109.4	
100% Traction (normal operation)	Upper	+75.0	-60.1	+50.5	+59.6	9 982 590
	Lower	-75.0	+60.1	-50.5	-59.6	
Damage Equivalent load m=5	Upper	+75.02	-60.09	+50.63	+59.8	10 000 000
	Lower	-75.02	+60.09	-50.63	-59.8	
Damage Equivalent load m=7	Upper	+75.05	-60.09	+50.82	+60.31	10 000 000
	Lower	-75.05	+60.09	-50.82	-60.31	

Table 7: load collective for longitudinal fatigue loads for endurance limit approach (1E7 load cycles)

4.5 Fatigue Load Combinations

The upper and lower vertical fatigue load (FLC01u, FLC01l) is superimposed with the longitudinal and lateral fatigue loadcases of FLC02 to FLC04. Loadgroup A and Loadgroup B from Table 8 are two separate fatigue scenarios depending on the installation direction of the joint. Loadgroup A combines the longitudinal fatigue loads of the first joint (EWB-MW7: Center pin on side of train end) with the maximum vertical and lateral fatigue loads. Loadgroup B combines the longitudinal fatigue loads of the second joint (EW7-MW6: Center pin on side of train middle) with the maximum vertical and lateral fatigue loads.

Load-case	F _{x1}	F _{y1}	F _{z1}	F _{x,BOG}	F _{y,BOG}	F _{y,D}	Description of the Loadcase combination		
FCOMB	[kN]	[kN]	[kN]	[kN]	[kN]	[kN]			
23	F _{x1}	12.7	22.4	F _{x,BOG}	-22.5		FCOMB 23 = FLC01u + FLC02u + FLC04u	Loadgroup A (Fx: EWB-MW7)	
24	F _{x1}	12.7	16.6	F _{x,BOG}	-22.5		FCOMB 24 = FLC01l + FLC02u + FLC04u		
25	F _{x1}	-12.7	22.4	F _{x,BOG}	22.5		FCOMB 25 = FLC01u + FLC02l + FLC04u		
26	F _{x1}	-12.7	16.6	F _{x,BOG}	22.5		FCOMB 26 = FLC01l + FLC02l + FLC04u		
27	-F _{x1}	12.7	22.4	-F _{x,BOG}	-22.5		FCOMB 27 = FLC01u + FLC02u + FLC04l		
28	-F _{x1}	12.7	16.6	-F _{x,BOG}	-22.5		FCOMB 28 = FLC01l + FLC02u + FLC04l		
29	-F _{x1}	-12.7	22.4	-F _{x,BOG}	22.5		FCOMB 29 = FLC01u + FLC02l + FLC04l		
30	-F _{x1}	-12.7	16.6	-F _{x,BOG}	22.5		FCOMB 30 = FLC01l + FLC02l + FLC04l		
31	F _{x1}	19.1	22.4	F _{x,BOG}	0.6	TBD	FCOMB 31 = FLC01u + FLC03u + FLC04u		
32	F _{x1}	19.1	16.6	F _{x,BOG}	0.6	TBD	FCOMB 32 = FLC01l + FLC03u + FLC04u		
33	F _{x1}	-19.1	22.4	F _{x,BOG}	-0.6	TBD	FCOMB 33 = FLC01u + FLC03l + FLC04u		
34	F _{x1}	-19.1	16.6	F _{x,BOG}	-0.6	TBD	FCOMB 34 = FLC01l + FLC03l + FLC04u		
35	-F _{x1}	19.1	22.4	-F _{x,BOG}	0.6	TBD	FCOMB 35 = FLC01u + FLC03u + FLC04l		
36	-F _{x1}	19.1	16.6	-F _{x,BOG}	0.6	TBD	FCOMB 36 = FLC01l + FLC03u + FLC04l		
37	-F _{x1}	-19.1	22.4	-F _{x,BOG}	-0.6	TBD	FCOMB 37 = FLC01u + FLC03l + FLC04l		
38	-F _{x1}	-19.1	16.6	-F _{x,BOG}	-0.6	TBD	FCOMB 38 = FLC01l + FLC03l + FLC04l		
39	F _{x1}	12.7	-22.4	F _{x,BOG}	-22.5		FCOMB39=-FLC01u+FLC02u+FLC04u		Load group
40	F _{x1}	12.7	-16.6	F _{x,BOG}	-22.5		FCOMB40=-FLC01l+FLC02u+FLC04u		

Load-case	F _{x1}	F _{y1}	F _{z1}	F _{x,BOG}	F _{y,BOG}	F _{y,D}	Description of the Loadcase combination
FCOMB	[kN]	[kN]	[kN]	[kN]	[kN]	[kN]	
41	F _{x1}	-12.7	-22.4	F _{x,BOG}	22.5		FCOMB41=-FLC01u+FLC02l+FLC04u
42	F _{x1}	-12.7	-16.6	F _{x,BOG}	22.5		FCOMB42=-FLC01l+FLC02l+FLC04u
43	-F _{x1}	12.7	-22.4	-F _{x,BOG}	-22.5		FCOMB43=-FLC01u+FLC02u+FLC04l
44	-F _{x1}	12.7	-16.6	-F _{x,BOG}	-22.5		FCOMB44=-FLC01l+FLC02u+FLC04l
45	-F _{x1}	-12.7	-22.4	-F _{x,BOG}	22.5		FCOMB45=-FLC01u+FLC02l+FLC04l
46	-F _{x1}	-12.7	-16.6	-F _{x,BOG}	22.5		FCOMB46=-FLC01l+FLC02l+FLC04l
47	F _{x1}	19.1	-22.4	F _{x,BOG}	0.6	TBD	FCOMB47=-FLC01u+FLC03u+FLC04u
48	F _{x1}	19.1	-16.6	F _{x,BOG}	0.6	TBD	FCOMB48=-FLC01l+FLC03u+FLC04u
49	F _{x1}	-19.1	-22.4	F _{x,BOG}	-0.6	TBD	FCOMB49=-FLC01u+FLC03l+FLC04u
50	F _{x1}	-19.1	-16.6	F _{x,BOG}	-0.6	TBD	FCOMB50=-FLC01l+FLC03l+FLC04u
51	-F _{x1}	19.1	-22.4	-F _{x,BOG}	0.6	TBD	FCOMB51=-FLC01u+FLC03u+FLC04l
52	-F _{x1}	19.1	-16.6	-F _{x,BOG}	0.6	TBD	FCOMB52=-FLC01l+FLC03u+FLC04l
53	-F _{x1}	-19.1	-22.4	-F _{x,BOG}	-0.6	TBD	FCOMB53=-FLC01u+FLC03l+FLC04l
54	-F _{x1}	-19.1	-16.6	-F _{x,BOG}	-0.6	TBD	FCOMB54=-FLC01l+FLC03l+FLC04l

Table 8: Fatigue loadcase combinations ; ECOMBXXa : negative vertical loading ; ECOMBXXb : positive vertical loading

The structural evaluation of the load combinations of Table 8 and the single load cases of chapter 4.4 shall be performed according DTRF150209 [R4].

To determine the critical range for the fatigue evaluation, ranges between all FCOMB within one Load group shall be created. It is not necessary to create ranges between the two Load groups.

A – APPENDICES

A– 1 Longitudinal Joint Loads (MND500, 100% traction)

MND500_100% traction input data																							
CBS		EWB	MW7	MW6	MW5	MW-Z2	MW4	MW-Z1	MW3	MW2	MW1	EWA											
CBS mass [kg]		31524	15103	17398	15613	11521	15862	11521	15613	17398	15102	31514											
Normal Payload [kg]		15033	11397	16499	16499	11397	17168	11397	16499	16499	11397	15033											
Total CBS mass [kg]		46557	26500	33897	32112	22918	33030	22918	32112	33897	26499	46547											
Bogie		MB	MB	MB	TB	TB	TB	TB	TB	TB	MB	MB	MB										
Bogie mass [kg]		3798	4150	4619	2175	2084	2084	2084	2084.0	2175.0	4619.0	4150.0	3798										
Rotational mass [kg]		4744	4712	4712	2855	2512	2512	2512	2512.0	2855.0	4712.0	4712.0	4744										
Total Bogie mass [kg]		8542	8862	9331	5030	4596	4596	4596	4596.0	5030.0	9331.0	8862.0	8542										
Number of motor bogie		1	1	1	0	0	0	0	0	0	1	1	1										
Traction acceleration [G]		0.0975																					
Total trainset mass [kg]		438901																					
Traction Force per Bogie [N]		70000	70000	70000	0	0	0	0	0	0	70000	70000	70000										
Inertia Force per Bogie [N]		8174	8480	8929	4813	4398	4398	4398	4398	4813	8929	8480	8174										
Traction Force per Pivot/Traction bar [N]		61826	61520	61071	-4813	-4398	-4398	-4398	-4398	-4813	61071	61520	61826										
Inertia Force per CBS [N]		44552	25359	32437	30729	21931	31608	21931	30729	32437	25358	44542											
Male/Female Joint		-	f	m	m	f	m	f	m	f	m	f	-										
Coupler/articulation interface force [kN]		0.00	78.79	-78.79	53.43	-114.51	77.25	-77.25	46.53	-42.13	20.20	-15.80	-20.21	20.21	-46.54	46.54	-77.27	82.08	-53.45	53.45	-78.80	17.28	0.00
Articulation Pin Force [kN]		-	78.79		53.43		77.25		46.53		20.20		20.21		46.54		77.27		53.45		78.80		

A– 2 Longitudinal Joint Loads (MND280, 100% traction)

MND280_100% traction input data																							
CBS		EWB	MW7	MW6	MW5	MW-Z2	MW4	MW-Z1	MW3	MW2	MW1	EWA											
CBS mass [kg]		31524	15103	17398	15613	11521	15862	11521	15613	17398	15102	31514											
Normal Payload [kg]		9404	6875	10102	10102	6875	10230	6875	10102	10102	6875	9404											
Total CBS mass [kg]		40928	21978	27500	25715	18396	26092	18396	25715	27500	21977	40918											
Bogie		MB	MB	MB	TB	TB	TB	TB	TB	TB	MB	MB	MB										
Bogie mass [kg]		3798	4150	4619	2175	2084	2084	2084	2084.0	2175.0	4619.0	4150.0	3798										
Rotational mass [kg]		4744	4712	4712	2855	2512	2512	2512	2512.0	2855.0	4712.0	4712.0	4744										
Total Bogie mass [kg]		8542	8862	9331	5030	4596	4596	4596	4596.0	5030.0	9331.0	8862.0	8542										
Number of motor bogie		1	1	1	0	0	0	0	0	0	1	1	1										
Traction acceleration [G]		0.1136																					
Total trainset mass [kg]		377029																					
Traction Force per Bogie [N]		70000	70000	70000	0	0	0	0	0	0	70000	70000	70000										
Inertia Force per Bogie [N]		9516	9872	10394	5603	5120	5120	5120	5120	5603	10394	9872	9516										
Traction Force per Pivot/Traction bar [N]		60484	60128	59606	-5603	-5120	-5120	-5120	-5120	-5603	59606	60128	60484										
Inertia Force per CBS [N]		45593	24483	30634	28646	20493	29066	20493	28646	30634	24482	45582											
Male/Female Joint		-	f	m	m	f	m	f	m	f	m	f	-										
Coupler/articulation interface force [kN]		0.00	75.02	-75.02	50.54	-110.14	73.90	-73.90	45.26	-40.14	19.65	-14.53	-19.66	19.66	-45.27	45.27	-73.92	79.52	-50.55	50.55	-75.03	14.90	0.00
Articulation Pin Force [kN]		-	75.02		50.54		73.90		45.26		19.65		19.66		45.27		73.92		50.55		75.03		

A- 3 Longitudinal Joint Loads (MND500, 50% traction)

MND500_50% traction input data																							
Traction	CBS		EWB	MW7	MW6	MW5	MW-Z2	MW4	MW-Z1	MW3	MW2	MW1	EWA										
	CBS mass [kg]		31524	15103	17398	15613	11521	15862	11521	15613	17398	15102	31514										
	Normal Payload [kg]		15033	11397	16499	16499	11397	17168	11397	16499	16499	11397	15033										
	Total CBS mass [kg]		46557	26500	33897	32112	22918	33030	22918	32112	33897	26499	46547										
	Bogie		MB	MB	MB	TB	TB	TB	TB	TB	TB	MB	MB	MB									
	Bogie mass [kg]		3798	4150	4619	2175	2084	2084	2084	2084.0	2175.0	4619.0	4150.0	3798									
	Rotational mass [kg]		4744	4712	4712	2855	2512	2512	2512	2512.0	2855.0	4712.0	4712.0	4744									
	Total Bogie mass [kg]		8542	8862	9331	5030	4596	4596	4596	4596.0	5030.0	9331.0	8862.0	8542									
	Number of motor bogie		1	1	1	0	0	0	0	0	0	0	0	0									
	Traction acceleration [G]		0.0488																				
	Total trainset mass [kg]		438901																				
	Traction Force per Bogie [N]		70000	70000	70000	0	0	0	0	0	0	0	0	0									
	Inertia Force per Bogie [N]		4087	4240	4465	2407	2199	2199	2199	2199	2199	4465	4240	4087									
	Traction Force per Pivot/Traction bar [N]		65913	65760	65535	-2407	-2199	-2199	-2199	-2199	-2407	-4465	-4240	-4087									
Inertia Force per CBS [N]		22276	12679	16219	15365	10966	15804	10966	15365	16219	12679	22271	-										
Male/Female Joint		-	f	m	f	m	f	m	f	m	f	m	f										
Coupler/articulation Interface force [kN]		0.00	109.40	-109.40	96.72	-162.25	143.63	-143.63	128.26	-126.06	115.10	-112.90	94.90	-94.90	81.73	-81.73	66.37	-63.96	43.28	-43.28	30.60	-26.36	0.00
Articulation Pin Force [kN]		-	109.40	96.72	143.63	128.26	115.10	94.90	81.73	66.37	43.28	30.60	-										

A- 4 Longitudinal Joint Loads (MND280, 50% traction)

MND280_50% traction input data																							
Traction	CBS		EWB	MW7	MW6	MW5	MW-Z2	MW4	MW-Z1	MW3	MW2	MW1	EWA										
	CBS mass [kg]		31524	15103	17398	15613	11521	15862	11521	15613	17398	15102	31514										
	Normal Payload [kg]		9404	6875	10102	10102	6875	10230	6875	10102	10102	6875	9404										
	Total CBS mass [kg]		40928	21978	27500	25715	18396	26092	18396	25715	27500	21977	40918										
	Bogie		MB	MB	MB	TB	TB	TB	TB	TB	TB	MB	MB	MB									
	Bogie mass [kg]		3798	4150	4619	2175	2084	2084	2084	2084.0	2175.0	4619.0	4150.0	3798									
	Rotational mass [kg]		4744	4712	4712	2855	2512	2512	2512	2512.0	2855.0	4712.0	4712.0	4744									
	Total Bogie mass [kg]		8542	8862	9331	5030	4596	4596	4596	4596.0	5030.0	9331.0	8862.0	8542									
	Number of motor bogie		1	1	1	0	0	0	0	0	0	0	0	0									
	Traction acceleration [G]		0.0568																				
	Total trainset mass [kg]		377029																				
	Traction Force per Bogie [N]		70000	70000	70000	0	0	0	0	0	0	0	0	0									
	Inertia Force per Bogie [N]		4758	4936	5197	2802	2560	2560	2560	2560	2560	5197	4936	4758									
	Traction Force per Pivot/Traction bar [N]		65242	65064	64803	-2802	-2560	-2560	-2560	-2560	-2802	-5197	-4936	-4758									
Inertia Force per CBS [N]		22796	12241	15317	14323	10246	14533	10246	14323	15317	12241	22791	-										
Male/Female Joint		-	f	m	f	m	f	m	f	m	f	m	f										
Coupler/articulation Interface force [kN]		0.00	107.51	-107.51	95.27	-160.07	141.95	-141.95	127.63	-125.07	114.82	-112.26	95.17	-95.17	82.36	-82.36	68.04	-65.24	44.73	-44.73	32.48	-27.55	0.00
Articulation Pin Force [kN]		-	107.51	95.27	141.95	127.63	114.82	95.17	82.36	68.04	44.73	32.48	-										

A- 5 Longitudinal Joint Loads (MND280, Service braking)

MND500_emerg braking input data																							
	CBS	EWB		MW7		MW6		MW5		MW-Z2		MW4		MW-Z1		MW3		MW2		MW1		EWA	
	CBS mass [kg]	31524	15103	15103	17398	17398	15613	15613	11521	11521	15862	15862	11521	15613	15613	17398	17398	15102	15102	11397	11397	15033	
	Normal Payload [kg]	15033	11397	11397	16499	16499	16499	16499	11397	11397	17168	17168	11397	16499	16499	16499	16499	11397	11397	16499	16499	15033	
	Total CBS mass [kg]	46557	26500	26500	33897	33897	32112	32112	22918	22918	33030	33030	22918	32112	32112	33897	33897	26499	26499	26499	26499	46547	
Braking	Bogie	MB	MB	MB	TB	TB	TB	TB	TB	TB	TB	TB	TB	TB	TB	MB	MB	MB	MB	MB	MB	MB	
	Bogie mass [kg]	3798	4150	4619	2175	2175	2084	2084	2084	2084	2084	2084	2084	2084.0	2175.0	4619.0	4150.0	4150.0	4150.0	3798	3798	3798	
	Rotational mass [kg]	4744	4712	4712	2855	2855	2512	2512	2512	2512	2512	2512	2512	2512.0	2855.0	4712.0	4712.0	4712.0	4712.0	4744	4744	4744	
	Total Bogie mass [kg]	8542	8862	9331	5030	5030	4596	4596	4596	4596	4596	4596	4596	4596.0	5030.0	9331.0	8862.0	8862.0	8862.0	8542	8542	8542	
	Number of magnetic brakes	0	0	1	0	0	0	0	0	0	0	0	0	0	0	1	0	0	0	0	0	0	
	Traction acceleration [G]	-0.1561																					
	Total trainset mass [kg]	438901																					
	Brake Force per Bogie [N]	-42000	-42000	-126000	-42000	-42000	-42000	-42000	-42000	-42000	-42000	-42000	-42000	-42000	-42000	-42000	-126000	-42000	-42000	-42000	-42000	-42000	
	Inertia Force per Bogie [N]	-13079	-13569	-14287	-7701	-7037	-7037	-7037	-7037	-7037	-7037	-7037	-7037	-7037	-7037	-7701	-14287	-13569	-13079	-13079	-13079	-13079	
	Brake Force per Pivot/Traction bar [N]	-28921	-28431	-111713	-34299	-34963	-34963	-34963	-34963	-34963	-34963	-34963	-34963	-34963	-34963	-34299	-111713	-28431	-28921	-28921	-28921	-28921	
	Inertia Force per CBS [N]	-71283	-40574	-51900	-49167	-35090	-50572	-35090	-49167	-51900	-40573	-71268											
	Male/Female Joint	-	f	m	f	m	f	m	f	m	f	m	f	m	f	m	f	m	f	m	f	m	
	Coupler/articulation Interface force [kN]	0.00	13.93	-13.93	54.50	57.21	-39.61	39.61	9.56	25.40	9.69	25.28	-9.67	9.67	-9.54	9.54	39.62	-5.33	-54.49	54.49	-13.92	42.35	0.00
	Articulation Pin Force [kN]	-	13.93	54.50	39.61	9.56	9.69	9.67	9.54	39.62	54.49	13.92											

A- 6 Longitudinal Joint Loads (MND280, Emergency braking)

MND280_service braking input data																							
	CBS	EWB		MW7		MW6		MW5		MW-Z2		MW4		MW-Z1		MW3		MW2		MW1		EWA	
	CBS mass [kg]	31524	15103	15103	17398	17398	15613	15613	11521	11521	15862	15862	11521	15613	15613	17398	17398	15102	15102	11397	11397	15033	
	Normal Payload [kg]	9404	6875	6875	10102	10102	10102	10102	6875	6875	10230	10230	6875	10102	10102	10102	10102	6875	6875	9404	9404	9404	
	Total CBS mass [kg]	40928	21978	21978	27500	27500	25715	25715	18396	18396	26092	26092	18396	25715	25715	27500	27500	21977	21977	21977	21977	40918	
Braking	Bogie	MB	MB	MB	TB	TB	TB	TB	TB	TB	TB	TB	TB	TB	TB	MB	MB	MB	MB	MB	MB	MB	
	Bogie mass [kg]	3798	4150	4619	2175	2175	2084	2084	2084	2084	2084	2084	2084	2084.0	2175.0	4619.0	4150.0	4150.0	4150.0	3798	3798	3798	
	Rotational mass [kg]	4744	4712	4712	2855	2855	2512	2512	2512	2512	2512	2512	2512	2512.0	2855.0	4712.0	4712.0	4712.0	4712.0	4744	4744	4744	
	Total Bogie mass [kg]	8542	8862	9331	5030	5030	4596	4596	4596	4596	4596	4596	4596	4596.0	5030.0	9331.0	8862.0	8862.0	8862.0	8542	8542	8542	
	Number of braking bogies	1	1	1	0	0	0	0	0	0	0	0	0	0	0	1	0	0	0	0	0	0	
	Traction acceleration [G]	-0.1240																					
	Total trainset mass [kg]	377029																					
	Brake Force per Bogie [N]	-71761	-73522	-73522	-3522	-3522	-3522	-3522	-3522	-3522	-3522	-3522	-3522	-3522	-3522	-3522	-73522	-73522	-73522	-73522	-73522	-71761	
	Inertia Force per Bogie [N]	-10393	-10783	-11353	-6120	-5592	-5592	-5592	-5592	-5592	-5592	-5592	-5592	-5592	-5592	-6120	-11353	-10783	-10393	-10393	-10393	-10393	
	Brake Force per Pivot/Traction bar [N]	-61368	-62739	-62169	2598	-31288	-22383	2070	2070	-31747	-22383	2070	2070	-31288	-22383	2070	2598	-33460	-62169	-62739	-61368	-61368	
	Inertia Force per CBS [N]	-49798	-26741	-33460	-31288	-22383	-31747	-22383	-31288	-26740	-49786												
	Male/Female Joint	-	f	m	f	m	f	m	f	m	f	m	f	m	f	m	f	m	f	m	f	m	
	Coupler/articulation Interface force [kN]	0.00	-74.31	74.31	-47.57	109.74	-73.68	73.68	-42.39	40.32	-17.94	15.87	17.95	-17.95	42.40	-42.40	73.69	-76.29	47.58	-47.58	74.32	-11.58	0.00
	Articulation Pin Force [kN]	-	74.31	47.57	73.68	42.39	17.94	15.87	17.95	42.40	73.69	47.58	74.32										

A- 7 Longitudinal Joint Loads (MND500, Service braking)

MND500_service braking input data																							
	CBS	EWB		MW7		MW6		MW5		MW-Z2		MW4		MW-Z1		MW3		MW2		MW1		EWA	
	CBS mass [kg]	31524	15103	15103	17398	17398	15613	15613	11521	11521	15862	15862	11521	11521	15613	15613	17398	17398	15102	15102	15102	31514	
	Normal Payload [kg]	15033	11397	11397	16499	16499	16499	16499	11397	11397	17168	17168	11397	11397	16499	16499	16499	16499	11397	11397	11397	15033	
	Total CBS mass [kg]	46557	26500	26500	33897	33897	32112	32112	22918	22918	33030	33030	22918	22918	32112	32112	33897	33897	26499	26499	26499	46547	
Braking	Bogie	MB	MB	MB	TB	TB	TB	TB	TB	TB	TB	TB	TB	TB	TB	TB	MB	MB	MB	MB	MB	MB	
	Bogie mass [kg]	3798	4150	4619	2175	2175	2084	2084	2084	2084	2084	2084	2084	2084	2084.0	2175.0	4619.0	4150.0	4150.0	4150.0	4150.0	3798	
	Rotational mass [kg]	4744	4712	4712	2855	2855	2512	2512	2512	2512	2512	2512	2512	2512.0	2512.0	2855.0	4712.0	4712.0	4712.0	4712.0	4712.0	4744	
	Total Bogie mass [kg]	8542	8862	9331	5030	5030	4596	4596	4596	4596	4596	4596	4596	4596.0	4596.0	5030.0	9331.0	8862.0	8862.0	8862.0	8862.0	8542	
	Number of braking bogies	1	1	1	0	0	0	0	0	0	0	0	0	0	0	0	1	1	1	1	1	1	
	Traction acceleration [G]	-0.1065																					
	Total trainset mass [kg]	438901																					
	Brake Force per Bogie [N]	-71761	-73522	-73522	-3522	-3522	-3522	-3522	-3522	-3522	-3522	-3522	-3522	-3522	-3522	-3522	-3522	-73522	-73522	-73522	-73522	-73522	-71761
	Inertia Force per Bogie [N]	-8928	-9263	-9263	-9753	-5257	-4804	-4804	-4804	-4804	-4804	-4804	-4804	-4804	-4804	-4804	-4804	-9753	-9263	-9263	-9263	-9263	-8928
	Brake Force per Pivot/Traction bar [N]	-62833	-64259	-63769	1735	1282	1282	1282	1282	1282	1282	1282	1282	1282	1282	1282	1735	-63769	-64259	-62833	-62833	-62833	-62833
	Inertia Force per CBS [N]	-48662	-27698	-35429	-33564	-23954	-34523	-23954	-33564	-35429	-27697	-48651	-	-	-	-	-	-	-	-	-	-	-
	Male/Female Joint	-	f	m	f	m	f	m	f	m	f	m	f	m	f	m	f	m	f	m	f	m	f
	Coupler/articulation Interface force [kN]	0.00	-78.43	78.43	-50.73	114.50	-77.34	77.34	-43.77	42.49	-18.54	17.26	18.55	-18.55	43.78	-43.78	77.35	-79.08	50.74	-50.74	78.44	-14.18	0.00
	Articulation Pin Force [kN]	-	78.43	50.73	77.34	43.77	18.54	18.55	43.78	77.35	50.74	78.44	-	-	-	-	-	-	-	-	-	-	-

A- 8 Longitudinal Joint Loads (MND500, Emergency braking)

MND500_emerg braking input data																							
	CBS	EWB		MW7		MW6		MW5		MW-Z2		MW4		MW-Z1		MW3		MW2		MW1		EWA	
	CBS mass [kg]	31524	15103	15103	17398	17398	15613	15613	11521	11521	15862	15862	11521	11521	15613	15613	17398	17398	15102	15102	15102	31514	
	Normal Payload [kg]	15033	11397	11397	16499	16499	16499	16499	11397	11397	17168	17168	11397	11397	16499	16499	16499	16499	11397	11397	11397	15033	
	Total CBS mass [kg]	46557	26500	26500	33897	33897	32112	32112	22918	22918	33030	33030	22918	22918	32112	32112	33897	33897	26499	26499	26499	46547	
Braking	Bogie	MB	MB	MB	TB	TB	TB	TB	TB	TB	TB	TB	TB	TB	TB	TB	MB	MB	MB	MB	MB	MB	
	Bogie mass [kg]	3798	4150	4619	2175	2175	2084	2084	2084	2084	2084	2084	2084	2084	2084.0	2175.0	4619.0	4150.0	4150.0	4150.0	4150.0	3798	
	Rotational mass [kg]	4744	4712	4712	2855	2855	2512	2512	2512	2512	2512	2512	2512	2512.0	2512.0	2855.0	4712.0	4712.0	4712.0	4712.0	4712.0	4744	
	Total Bogie mass [kg]	8542	8862	9331	5030	5030	4596	4596	4596	4596	4596	4596	4596	4596.0	4596.0	5030.0	9331.0	8862.0	8862.0	8862.0	8862.0	8542	
	Number of magnetic brakes	0	0	1	0	0	0	0	0	0	0	0	0	0	0	0	1	0	0	0	0	0	
	Traction acceleration [G]	-0.1561																					
	Total trainset mass [kg]	438901																					
	Brake Force per Bogie [N]	-42000	-42000	-126000	-42000	-42000	-42000	-42000	-42000	-42000	-42000	-42000	-42000	-42000	-42000	-42000	-42000	-126000	-42000	-42000	-42000	-42000	-42000
	Inertia Force per Bogie [N]	-13079	-13569	-14287	-7701	-7037	-7037	-7037	-7037	-7037	-7037	-7037	-7037	-7037	-7037	-7037	-7037	-14287	-13569	-13569	-13569	-13079	
	Brake Force per Pivot/Traction bar [N]	-28921	-28431	-111713	-34299	-34963	-34963	-34963	-34963	-34963	-34963	-34963	-34963	-34963	-34963	-34963	-34299	-111713	-28431	-28921	-28921	-28921	-28921
	Inertia Force per CBS [N]	-71283	-40574	-51900	-49167	-35090	-50572	-35090	-49167	-71268	-	-	-	-	-	-	-	-	-	-	-	-	-
	Male/Female Joint	-	f	m	f	m	f	m	f	m	f	m	f	m	f	m	f	m	f	m	f	m	f
	Coupler/articulation Interface force [kN]	0.00	13.93	-13.93	54.50	57.21	-39.61	39.61	9.56	25.40	9.69	25.28	-9.67	9.67	-9.54	9.54	39.62	-5.33	-54.49	54.49	-13.92	42.35	0.00
	Articulation Pin Force [kN]	-	13.93	54.50	39.61	9.56	25.40	9.69	25.28	9.67	9.54	39.62	5.33	54.49	13.92	42.35	0.00	-	-	-	-	-	-

A- 9 Vertical loads : Lifting with bogie attached

Configuration	EW-MW1	MW1-MW2	MW2-MW3	MW3-MW_ZW	MW_ZW-MW4
m_b [kg]	8862	9331	5030	4596	4596
Re-railed vehicle	MW1	MW2	MW3	MW-ZW	MW4
$M_{running_order}$ [kg]	31524	15103	17398	15613	11521
e1 [mm]	0	0	0	0	0
d1 [mm]	16180	11020	16180	16180	11020
x_{g1} [mm]	11231	5510	8090	8090	5510
F* [kN]	199.680	182.179	148.150	133.835	111.757
Weight acting on the articulation [kg]	20354.72	18570.75	15101.90	13642.75	11392.15
bogie lifting load [kN]	95.630	100.691	54.279	49.595	49.595
Re-railed vehicle	EW	MW1	MW2	MW3	MW-ZW
$M_{running_order}$ [kg]	15130	17398	15613	11521	15862
e1 [mm]	0	0	0	0	0
d1 [mm]	11020	16180	16180	11020	16180
x_{g1} [mm]	5510	8090	8090	5510	8090
F* [kN]	177.264	194.562	138.519	111.757	135.179
Weight acting on the articulation [kg]	18069.70	19833.00	14120.15	11392.15	13779.70
bogie lifting load [kN]	95.630	100.691	54.279	49.595	49.595