



ENGINEERING	APPLICATIONS (Series of materials or equipment)	N° of the DRAWINGS

TECHNICAL SPECIFICATION

RAILWAY ROLLING STOCK CONSTRUCTION

		Date	Name	ALSTOM TRANSPORT SA		
	Edited	28/07/08	C.COETTE	© 2008 - ALSTOM Transport SA		
	Checked	28/07/08	L. MOYART	This document and information are the exclusive property of ALSTOM Transport SA		
A	10/12/15	Approved	28/07/08	GIELCZINSKI	Any publication, reproduction, presentation, adaptation or translation is prohibited without the written agreement of ALSTOM Transport SA.	
	Construction modifications			ALSTOM	Version :	English
/	28/07/08			Conception and requirements for electrical screwed assemblies		
		Gen. Spec.				
		Replace				
		Date	Name	Format	Scale :	Page
						1 /
		Checked			DTRF150222	18
		Homol.				Pages
Modifications						

MODIFICATION CHART

A	10/12/15	Complete revision of the document Conformity with the STM-E-015	L. MOYART
/	28/07/08	Creation	L. MOYART
Revision letter	Date	Description of the modification	Name

CONTENTS

1. PREAMBLE.....	6
2. INTRODUCTION	6
2.1 PURPOSE OF THE SPECIFICATION.....	6
2.2 SCOPE.....	7
2.3 REFERENCE DOCUMENTS	7
2.4 GENERALITIES.....	7
2.5 CONDITIONS OF THE CONDUCTING PARTS' SURFACES.....	8
3. CONCEPTION OF THE ASSEMBLY	9
3.1 SCREWS.....	9
3.2 NUTS	9
3.3 WASHERS	9
3.4 TIGHTENING TORQUE: SCREWED OR BOLTED CONNECTIONS.....	10
3.5 LOCK WIRE.....	10
3.6 LUBRICATION AND GREASING.....	10
3.7 REPLACEMENT OF THE BOLTING	10
4. REPRESENTATIVE ASSEMBLIES	11
4.1 ASSEMBLY WITH TERMINAL	11
4.2 ASSEMBLY WITHOUT TERMINAL.....	12
4.3 ASSEMBLY ON ISOLATOR.....	13
4.4 EARTHING	15
4.5 ASSEMBLY ON TERMINAL BOARD	17
5. CONTROL	18
5.1 MARKING	18
5.2 MASS PRODUCTION CONTROL METHODS.....	18
5.3 RETIGHTENING	18

Application

1. All requirements mentioned in this document should be applied to new projects signed after the release date of this DTRF revision.
2. For projects under development at the release date of this DTRF, all requirements mentioned in this document should be applied, except the tightening torque values. In that case, the values to be considered are those from DTRF150222 revision “/”.
3. For older projects and those renewed from projects prior to the release date of this DTRF, the decision to apply this DTRF shall be taken by the project manager.

We recommend to clearly identify the DTRF version you are using when establishing the screwed assemblies parts list.

1. PREAMBLE

This document is part of a group of specifications aiming at standardizing screwed assemblies by responding to performance needs and relying as much as possible on large-scale industrial mass production. The purpose of this series of documents is to make the work of designers, purchasers, industrials, and maintainers easier.

Specific training makes these documents easier to use.

The DTRF150222 follows the same model as the DTRF150210 and DTRF150214 (for mechanical use) but is applied to electrical screwed assemblies.

**This document does not replace the European Standards.
It relies on the European Standards to supplement them with specific requirements in keeping with the state of the art in railway design.**

2. INTRODUCTION

2.1 PURPOSE OF THE SPECIFICATION

This DTRF supplement the DTRF150214 to complete the electrical assemblies' specificities. This document falls under a global step of continuous improving and process control. It broaches the subject of the dominating factors in the tightening application. It mainly aims to define the assemblies' requirements, tightening torque values, and control processes that have to be followed for electrical screwed assemblies, while relying on the present standards.

The specifications of this document concern electrical screwed and bolted assemblies used throughout ALSTOM. The chart below illustrates the scope of this document.

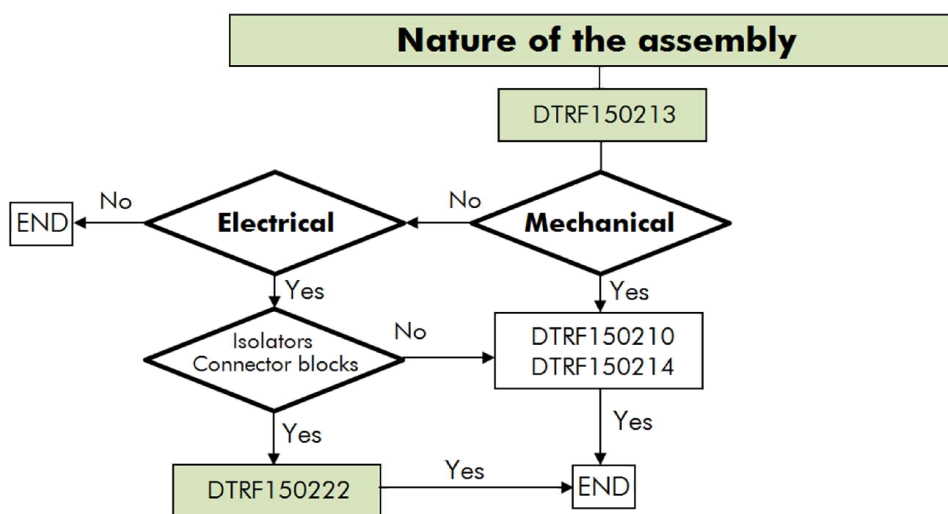

Various departments are responsible of the compliance of the constraints related to these requirements: purchase, design, methods, manufacturing, and inspection.

2.2 SCOPE

Will be considered in this DTRF:

- Screwed or bolted electrical connections.
- Electrical connections on isolators.
- Electrical connections on connector blocks.

These assemblies are covering most of the connections used.

However, every specific case will be treated through a dedicated specification (plan, process sheet) under the responsibility of the concerned site.

Will not be considered in this DTRF:

- Electrical connection on battery

2.3 REFERENCE DOCUMENTS

All the requirements of this specification are only based on the following present standards:

EN 50-343	Rules for installation of cabling
NF F 61-016	Connecting and electrical apparatus post insulators
NF F 61-017	Terminal blocks and component holder blocks
	Connections by means of quick connections (feathers) or threaded elements (studs)
DTRF150210	Screwed assemblies design
DTRF150213	Fasteners purchasing specification
DTRF150214	Requirements for screwed assemblies

2.4 GENERALITIES

The total of the contact resistance connection that opposes the current flow must produce a voltage drop compatible with the circuit operation. The temperature of the elements of the electrical connection must not be, in any case, higher than the thermic class of the conductors and electrical cables.

The performance of an electrical contact depends on the condition of the conducting parts surfaces. The dimensions of the contact surface depend on the density of the current and on the tightening pressure.

The components have to be mainly chosen between the official component list from ALSTOM, in other words the "Prefer Part List" (PPL) or the "Project Prefer Part List" (PPPL).

Each assembly has to be at least tightened by a torque.

The standard tightening torques is calculated in the following conditions:

- Calculation method following the NF E25-030-1 standard (Kellerman and Klein).
- Maximal equal strain for equal tightening for 90% of RE.

DTRF150222 Rev A	Electrical screwed assemblies - Conception and requirements	7/18
------------------	---	------

- Precision class C20.
- The tightening pressure on the surface in contact of the conductive pieces is included between 10 and 90 MPa in the conditions of the following figure with a plate washer NF E 25-518 in total support on the conductive piece.

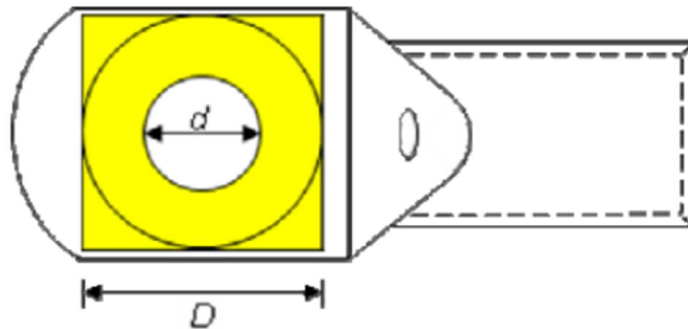

**Dimensions for the calculation of the useful surface of a contact
(Example for a cable terminal board)**

- Whatever the chosen washer type.

2.5 CONDITIONS OF THE CONDUCTING PARTS' SURFACES

The surfaces in contact must be plane and protected following the DTRF150400 standard. When assembling, these surfaces must be strictly clean. Any other interposed foreign substances would compromise the quality of the connection.

3. CONCEPTION OF THE ASSEMBLY

The protective coatings of screw and bolts must comply with the DTRF150213 standard. Therefore they will not be specified in the list of elements constituting the various assemblies defined in this document.

Furthermore, the constitutive elements of the connection will be in:

- Steel (class 8.8), if the connection is protected from weather conditions.
- Stainless steel (class A2), if the connection is not protected from weather conditions.

In order to avoid galvanic corrosion, it is advisable to employ suitable materials that are presenting an electrochemical potential difference higher than 300mV. This part is detailed in the poster RS-POST-150210-0-1.

The oblong holes are forbidden for the connections with terminal or with braid.

In the other cases (e.g.: distribution bar), the oblong hole is only expected for the adjustment in one direction:

- The width of the oblong hole has to be equal to the diameter of the associated screws' passage hole (NF EN 20273, series fine tolerance H12 or series medium tolerance H13)
- The passage hole large series is not allowed
- In nominal position, the oblong hole has to be centered compared to the screw

In the case of electrical connections with defined below oblong hole, it is necessary to use thick washers according to the E 25-518 standard and to assure that the exchange surface for the current density is respected.

3.1 SCREWS

The use of the following diameters is favored:

- M3, M4, M5, M6, M8, M10, M12, M16, M20.

The diameters M14 and M18 are not allowed except in case of exception subjected to a technical justification.

Coarse and metric threads have to be employed.

3.2 NUTS

The set has to be homogeneous. The nuts class must be equal to the class of the screws they are associated with, and must feature a locking system.

3.3 WASHERS

According to the different standards, the washers should be chosen in keeping with the selected assembly and among the following list:

- Spring washer assembled with 3 elements (TREP® type).
- CS washer NF E 25-511
 - o Small series for M3, M4 et M5
 - o Normal series (large accepted) for $D \geq M6$

- Large plate washer ISO 7093-1 with a minimal hardness equal to 300 HV (200 HV accepted in case of supply difficulties).
- Large thick washer according to E 25-518, the serie L or Z will be chosen according to the table 4.1 of this document

3.4 TIGHTENING TORQUE: SCREWED OR BOLTED CONNECTIONS

ALSTOM standardized the tightening torques between the electrical and mechanical assemblies. The reference document is the DTRF150214 "Tightening with a torque wrench – Performance class C2 assemblies". This paragraph gives the value of the tightening torque for a tolerance of variability of 20% (before CPC2).

3.5 LOCK WIRE

The use of lock wire is prohibited for the electrical standard connections.

3.6 LUBRICATION AND GREASING

3.6.1 MECHANICAL GREASING

The MOLYKOTE™ grease used on the stainless steel hardware ($\varnothing \geq 8$ mm) does not have to touch the connectors.

3.6.2 GREASING OF ELECTRICAL CONTACT

The contact grease:

- Fill the roughness on the surface of the electrical contact elements in order to reduce the impedance of the connection and to facilitate the electrical exchanges.
- Can be used on the exterior connection if needed.
- Does not have to be used to resolve the galvanic cell problematics.
- Must be indicated on the assembly drawing when it is used.
- Does not have to be put on the hardware (mandatory).
- Does not have to be put on the stainless steel screws with MOLYKOTE™ grease (mandatory).

3.7 REPLACEMENT OF THE BOLTING

All the fixation elements must be replaced after disassembly.

4. REPRESENTATIVE ASSEMBLIES

4.1 ASSEMBLY WITH TERMINAL

The table below describes the pile of a screwed and bolted assembly following the different standard cases of assembly with cable lug in conformity with the NF F 00-363 standard:

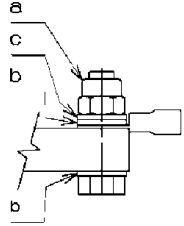
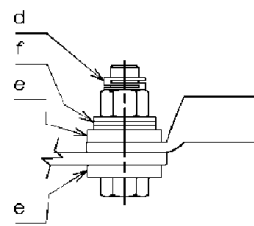
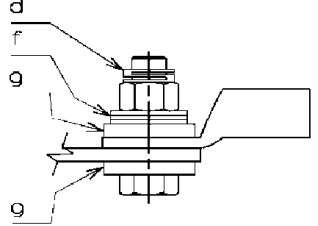
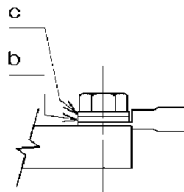
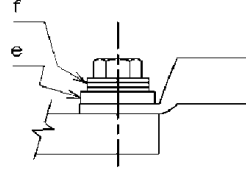
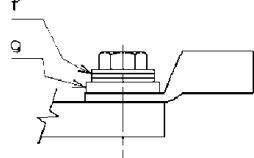
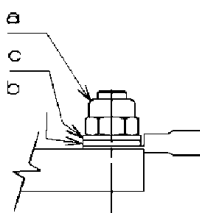
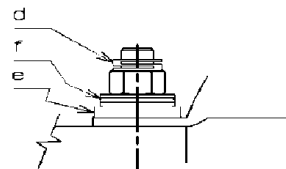
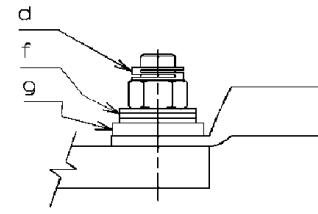
	$d \leq M5$	$M6 \leq d \leq M12$	$d \geq M16$
Bolted assembly	<p>a. HFR nut with nonmetallic ring (a) b. 2 plate washers NF EN ISO 7089 c. 1 narrow CS washer NF E 25-511 nut side</p> 	<p>d. Two slots HFR nut e. 2 thick plate washers series "L" E 25-518 f. 1 conical smooth washer 3L (TREP® type) or medium CS washer NF E 25-511 tolerated in the nut side</p> 	<p>d. two slots HFR nut g. 2 thick plate washers series "Z" E 25-518 f. 1 conical smooth washer 3L (TREP® type) nut side</p> 
Screwed assembly in steel or stainless steel	<p>b. 1 plate washer NF EN ISO 7089 c. 1 narrow CS washer NF E 25-511</p> 	<p>e. 1 thick plate washer series "L" E 25-518 f. 1 conical smooth washer 3L (TREP® type) or medium CS washer NF E 25-511 tolerated</p> 	<p>g. 1 thick plate washer series "Z" E 25-518 f. 1 conical smooth washer 3L (TREP® type)</p> 
Assembly on gudgeon established in steel or stainless steel	<p>a. HFR nut with nonmetallic ring b. 1 plate washer NF EN ISO 7089 c. 1 narrow CS washer NF E 25-511 nut side</p> 	<p>d. two slots HFR nut e. 1 thick plate washer series "L" E 25-518 f. 1 conical smooth washer 3L (TREP® type) or medium CS washer NF E 25-511 tolerated in the nut side</p> 	<p>d. two slots HFR nut g. 1 thick plate washer series "Z" E 25-518 f. 1 conical smooth washer 3L (TREP® type) nut side</p> 

The torques that must be applied are described in the DTRF150214 "Tightening with a torque wrench – Performance class C2 assemblies".

4.2 ASSEMBLY WITHOUT TERMINAL

4.2.1 HIGH POWER ASSEMBLY

It is considered that a high power assembly correspond to an electrical circuit intensity over or equal to 100 A.

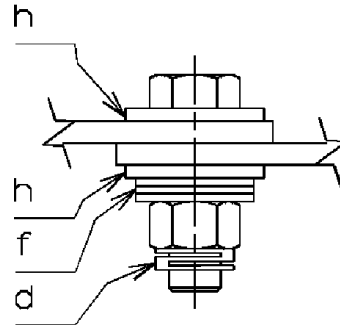

The assembly is composed of:

- d. two slots HFR nut
- f. Conical smooth washer 3L (TREP® type)
- h. Plate washer ISO 7093-1 (one for a screwed assembly and two for a bolted assembly)

4.2.2 LOW POWER ASSEMBLY

It is considered that a low power assembly correspond to an electrical circuit intensity under 100 A.

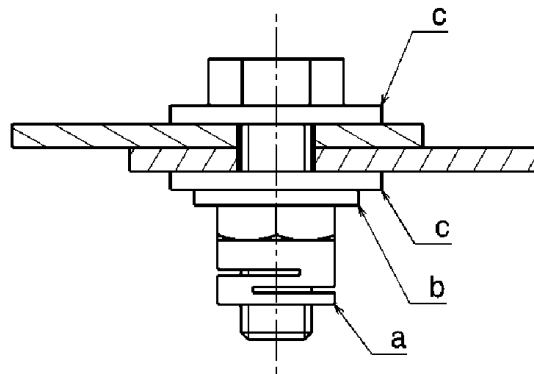

The assembly is composed of:

- a. two slots HFR nut
- b. Large CS washer NF E 25-511
- c. Plate washer ISO 7093-1 (one for a screwed assembly and two for a bolted assembly)

4.3 ASSEMBLY ON ISOLATOR

The isolator choice is made according to the NF F 61-016 standard.

4.3.1 CONNECTION ON ISOLATOR

Apply the assembly's recommendation and the tightening torque recommended by the supplier. To guaranty the stability of a mechanical screwed assembly, during the realization of the electrical assembly, the same torque can be used for the two assemblies on condition that medium lock wire is used on the mechanical assembly side.

The table below presents the tightening torques standards for the electrical connections on isolators.

The torque below are given by default, they can possibly change according to other suppliers.

d nominal (mm)	Tightening torque (N.m)
6	6
8	15
10	30
12	50
(14)*	80
16	115
(18)*	150

* These diameters must be avoided, in case of necessity, a technical justification is necessary.

4.3.2 ASSEMBLY WITH MAXIMUM TWO TERMINALS PER ISOLATOR

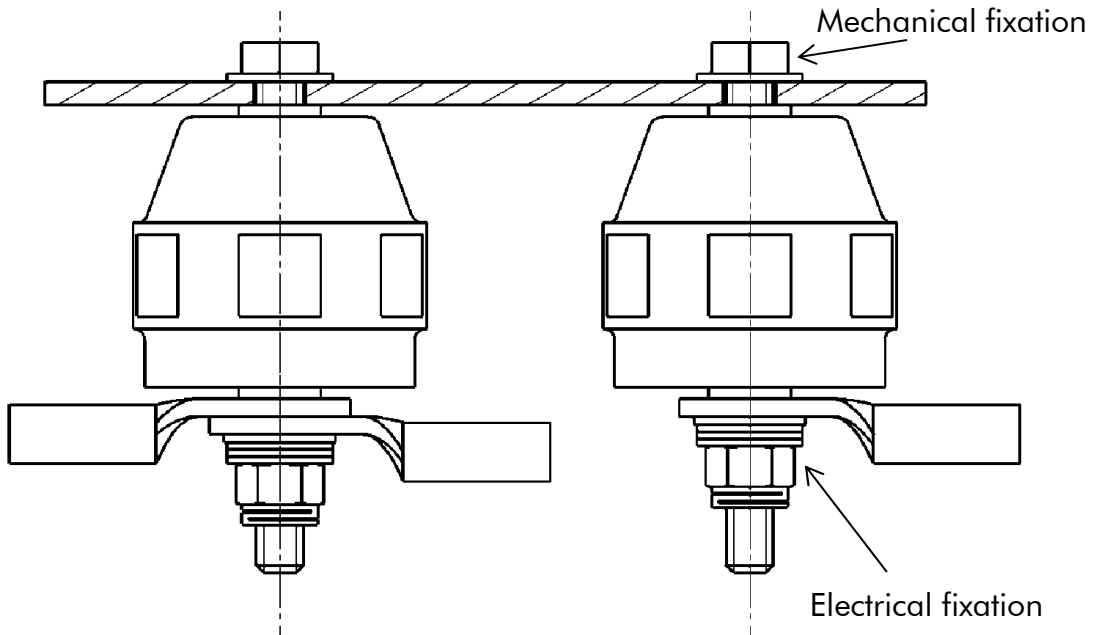

The assembly is composed of:

- two slots HFR nut
- Conical smooth washer (TREP® type)
- Plate washer ISO 7093-1

4.3.3 ASSEMBLY ON DISTRIBUTION BAR

A distribution bar retained by two isolators must be used for more than two terminals per isolator. The terminals must be on the connection bar.

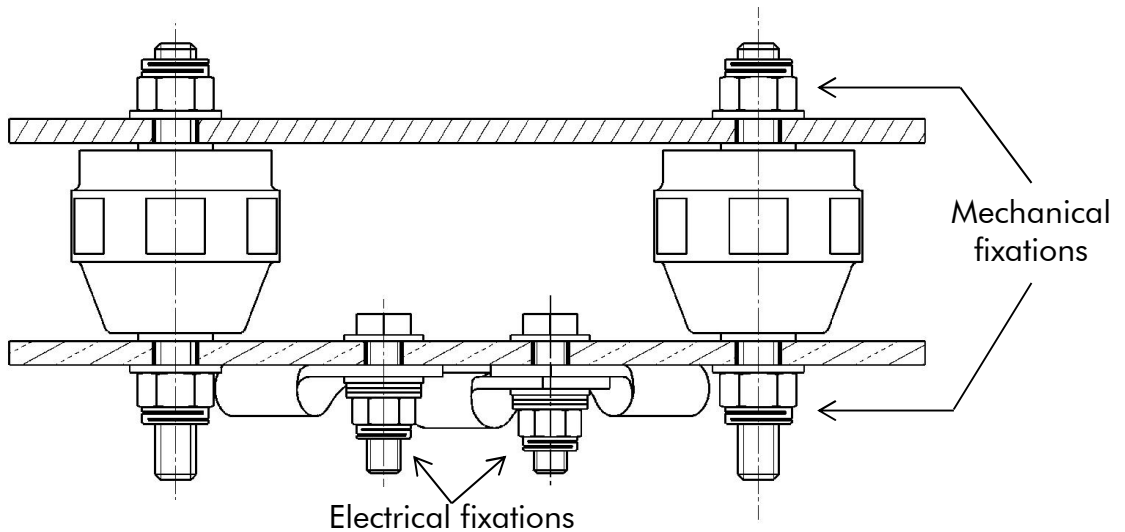

The assembly is composed of:

- Two slots HFR nut
- Conical smooth washer (TREP® type)
- Plate washer ISO 7093-1

It is forbidden to use isolators with socket insert for an electrical connection.

4.4 EARTHING

The pile and the torque to apply for the assembly of the earthing are determined according to the used elements.

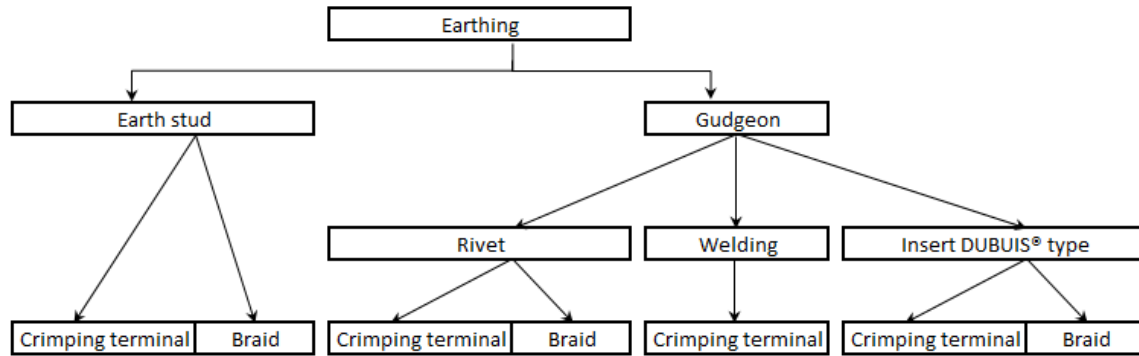

4.4.1 EARTHING STUD

The earth stud must be fixed with a continuous welding on the structure.

The earthing can be made with a terminal or a braid.

The values of the torque to apply are given in the DTRF150214 “Tightening with a torque wrench – Performance class C2 assemblies”.

4.4.1.1 ASSEMBLY WITH TERMINAL

For the pile, refer to §4.1 of this document.

4.4.1.2 ASSEMBLY WITH BRAID

The pile is made following the nature of the stud.

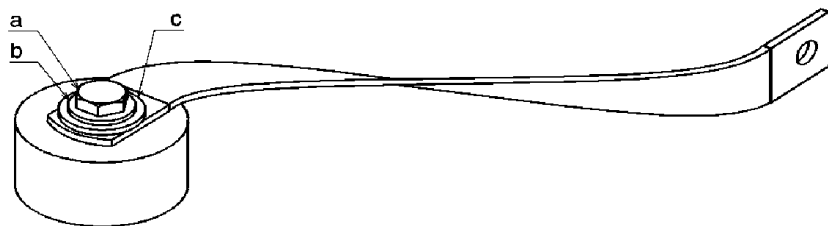

Nature of the stud: Stainless steel austenitic

- a. H head stainless steel A2 screw
- b. Large stainless steel CS washer NF E 25-511
- c. Plate stainless steel washer ISO 7093-1

Nature of the structure: Steel

Fixation: (preference) threaded blind hole on the stud

Nature of the stud: Treated aluminum for electrical conduction

- a. H head class 8.8 screw
- b. Large steel CS washer NF E 25-511
- c. Plate steel washer ISO 7093-1

Nature of the structure: Aluminum

Fixation: (mandatory) helicoil inserts without integrated breaking element

4.4.2 GUDGEONS

The gudgeons must be directly joined on an electrical conduction and anticorrosion treated frame.

The gudgeons must resist to minimum 1.5 times the value of the nominal tightening torque applicate on the electrical connection.

4.4.2.1 RIVET GUDGEON

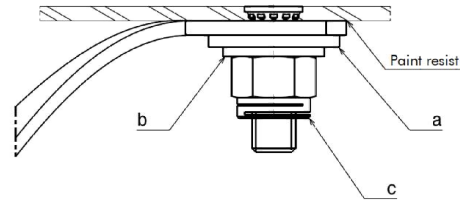

The assembly is composed of:

- a. Plate washer ISO 7093-1
- b. Medium CS washer NF E 25-511
- c. Two slots HFR nut

This type of assembly is suitable for braids or terminals.

4.4.2.2 WELDING GUDGEON

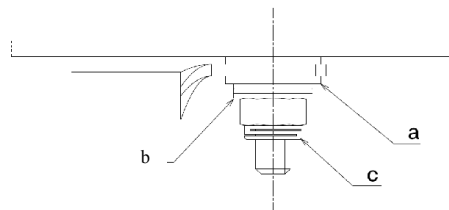

The generic assembly is composed of:

- a. Plate washer
- b. Conical smooth washer 3L TREP® type or medium CS washer tolerated
- c. HFR nut

This type of assembly is mainly suitable for the electrical assembly with terminals.

For the assembly details, refer to §4.1 of this document.

4.4.2.3 INSERT “DUBUIS™” TYPE

Give priority to the “DUBUIS™” inserts in case of additions or renovations.

The necessary information for the assembly of the “DUBUIS™” inserts (tolerances, torque values...) **are available in the documentation of the supplier** and must be scrupulously respected.

In the case of an electrical assembly with terminal, refer to §4.1 of this document.
 In the case of an electrical assembly with braid, refer to §4.4.1.2 of this document.



4.5 ASSEMBLY ON TERMINAL BOARD

The junction-blocks with threaded terminals that integrate their accessories must fulfill the conditions of the NF F 61-017 standard.

Two types of terminal boards are used: terminal board type BD and terminal board type BE. Both are presented in the following table.

Model of terminal board BD	Nominal diameter (mm)	Values of the tightening torques (N.m)
BD13,2	5	2,5
BD0016	5	2,5
BD0018	6	6
BD23,2	8	14
BD0025	8	14

Chart 1 – Electrical connections on terminal board BD

Model of terminal board BE	Nominal diameter (mm)	Values of the tightening torques (N.m)
BE0013	4	1,5
BE13,2	4	1,5
BE0014	5	2,5
BE0018	5	2,5

Chart 2 – Electrical connections on terminal board BE

5. CONTROL

5.1 MARKING

After tightening, the operator must absolutely proceed to the marking of the electrical connection.

The methods used for the application as well as the products that have to be used are defined in the DTRF150214 "Rules for marking the elements in production".

5.2 MASS PRODUCTION CONTROL METHODS

The control frequencies for the electrical assemblies are described in the DTRF150214 "Mass production control methods".

In the case of a safety level H, the control frequency can raise to 100% of the screws on all assemblies in agreement with the Project Quality and the PrEM.

5.3 RETIGHTENING

For the electrical assemblies, there is no post retightening.