



**ALSTOM STANDARD FOR RAILWAY APPLICATIONS
FASTENED ASSEMBLIES DESIGN**



TABLE OF MODIFICATIONS

Revision	Publication	Summary of Changes
P	26/05/23	Standard torque value transferred from DTRF 150214
O	01/12/22	Rationalization table, standard nut, design rules section and imperial fastener
N	24/03/21	New template, update of rationalization table
M	08/12/17	Rationalization table hexalobular screw / Table washer association rules
L	12/01/17	Rationalization table / NAV suppression / association rules / Tightening torques values indications
K	08/04/14	Rationalization table / nut with plastic insert / FS nut, superbolt
J	10/10/13	Hexalobular screw - update of the NOTA - Dimensional rules
I	02/07/13	Authorized and forbidden fastener list - Update of the NOTA
H	20/01/12	Definitions of secure assemblies
G	12/06/10	Suppression of solicitation category
F	10/10/09	Document reformatting following revisions mandated by Central Product Engineering
E	24/04/07	Performance levels / Preamble/ Galvanic corrosion / Correspondence with DTRF 150213 / suppression of theme-oriented organization / tightening torque
D	06/06/06	Title modification / Special shear constraints 6.2 / Elimination of appendix: Friction factor 8.2 / Bolted assemblies title block 5.3 Suppression of image of test on tensile binary 5.4.5
C	04/10/05	Correction anti-binding paste / Quality level C1 clamping: revised explanation / Suppression of chapter 6.2 special groupings following meeting of October 4th Return of experience on Nordlock solution – chapter 5.4.2.2
B	20/06/05	Correction of table on corrosion resistance, as well as designation example and addition of naming of bolted assemblies. Correction of clamping descriptions according to quality levels. Referencing to std. PrEN 15085 for the definition of security levels Appendix addition: Reminder for designers
A	01/06/05	Re-reading and addition of theoretical part following CCN meeting on 11/05/05
/	13/10/04	Original issue



CONTENTS

1. Purpose.....	5
2. Normative references	6
2.1. Standard references.....	6
2.2. ALSTOM Standard references	6
3. Terms and definition.....	6
4. Assembly classification	10
4.1. Bolted assembly safety level	10
4.2. Bolted assembly performance class	10
5. Deliverables.....	11
5.1. Assembly description	11
5.2. Additional information	11
6. Mechanical fasteners list	12
6.1. Authorized and standardized fasteners.....	12
6.1.1 Authorized and standardized screws.....	12
6.1.2 Authorized and standardized nuts.....	14
6.1.3 Authorized and standardized washers	14
6.1.4 Non-standardized fasteners	15
6.2. Prohibited fasteners.....	17
6.2.1 Prohibited screws.....	17
6.2.2 Prohibited nuts.....	18
6.2.3 Prohibited washers.....	19
7. Limitations on standardized fasteners.....	20
7.1. Limitations on diameter and material	20
7.1.1 Metric diameters	20
7.1.2 Imperial Diameters.....	20
7.2. Limitations on diameter and element types.....	20
7.2.1 Metric diameters	20
7.2.2 Imperial Diameters.....	23



7.3.	Limitations on screw lengths	26
7.4.	Limitations on fasteners depending on regions	26
8.	Design rules	27
8.1.	Selection and association rules	27
8.1.1	Selection according to zones.....	27
8.1.2	Associations rules following mechanical characteristics	27
8.1.3	Association rules about washer	27
8.1.4	Design rules	29
8.2.	Fastener additional protection after assembly.....	32
9.	Fundamental dimensioning criteria	33
9.1.	Assembly dimensioning	33
9.2.	Optimization rules for bolted assemblies	34
10.	Torque tightening values	35
10.1.	Standard torque values for nut – CP C20	36
10.1.1	Standard torque values for metric nut – CP C20.....	36
10.1.2	Standard torque values for imperial nut - CP C20.....	37
10.1.3	Standard torque values for imperial nut - CP C20 – Carbon steel hardware with Geomet 321+VL 38	
10.2.	Standard torque values for nut – CPC10	39
10.2.1	Standard torque values for nut CPC10 – metric screws	39
10.2.2	standard torque values for nut CPC10 - Imperial screws – Zinc Electroplate.....	40
10.2.3	standard torque values for nut CPC10 - Imperial screws – Geomet 321+VL	41
10.3.	Torque values for special assemblies	42
10.3.1	Metal assemblies - Metric screws.....	42
10.3.2	Metal assemblies - Imperial screws	43
10.3.3	Torque value for fiber reinforced plastic parts assembly (metric and imperial)	44
10.3.4	Torque value for plastic, elastomer and rubber assemblies (metric and imperial).....	44
11.	Department responsibility and tightening method	45
12.	Mounting prescriptions.....	45

1. PURPOSE

This ALSTOM Standard deals with railway screwed or bolted mechanical assemblies for structural or non-structural applications, as described below. It does not cover electrical assemblies, purpose of DTRF 150222.

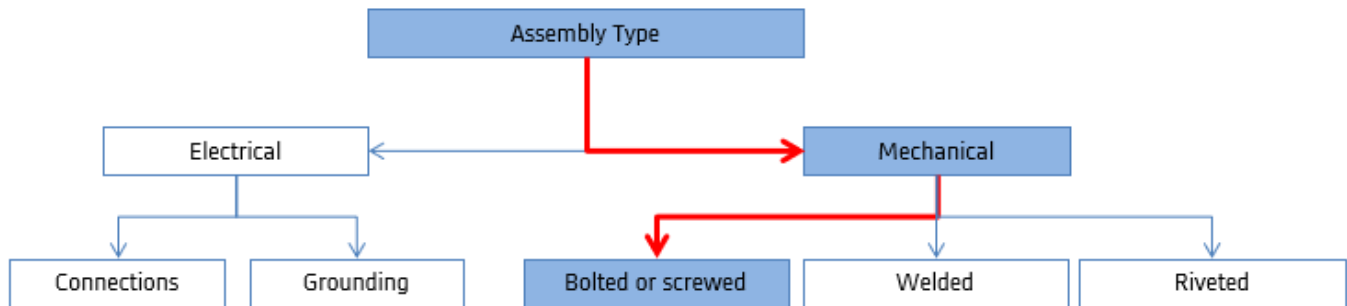

The purpose of this ALSTOM Standard is to define the performance class of an assembly, as well as the fundamental rules for design and dimensioning. This ALSTOM Standard neither aims at defining the standards of screwed elements (screwed elements catalogue), nor at defining procurement requirements (DTRF 150213).

ALSTOM's internal application of the mechanical fastening elements lists (authorized, forbidden, etc.) that appear in this ALSTOM Standard is used for new projects via the application of the standard element's lists: PPL (Preferred Part List).

Application of these technical solutions by suppliers:

- is not mandatory but strongly recommended for their component
- mandatory at the ALSTOM interface and approved during contract review.

In absence of European standard governing railway bolted joints and only when DIN 25201 is authorized for the considered project, this DTRF 150210 complements this standard.

Even if International Standards exist in different languages, English version is considered as official reference.

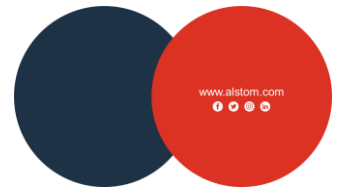

2. NORMATIVE REFERENCES

2.1. STANDARD REFERENCES



Reference	Title
EN 1993-8	Design of steel structure – Design of joints
ISO 273	Clearance hole for bolts and screws

2.2. ALSTOM STANDARD REFERENCES

Reference	Title
DTRF 150212	Assemblies and parts criticality management
DTRF 150213	Fasteners Purchasing Specification
DTRF 150214	Fastened Assemblies Mounting Requirements
DTRF 150250	Design Annotation & Dimension Instruction (DADI)
DTRF 150262	Washing and Cleaning Agents Specification
DTRF 150611	Surface protection catalogue

3. TERMS AND DEFINITION

- **Color codes definition:**

	Authorized or solution to be promoted
	Prohibited solution
	Authorized under condition, restricted use



TERM	DEFINITION
ASSEMBLIES	
Bolted assembly	A bolted assembly consists in a screw, at least two parts to be assembled together, a nut and possibly one or two washers.
Screwed assembly	A screwed assembly consists in a screw, a washer and a tapped part. It may also be used more broadly to designate an assembly containing at least one screw.
Structural assembly	An assembly is structural when its failure directly or indirectly leads to a dangerous situation for passengers, the operator, the maintenance personnel or leads to the damaging of the rolling stock itself. The term structural designates the removable or permanent mechanical connections of the train's sub-assemblies (cabin, side, underframe, roof, cross-members; ...), as well as equipment (seats, transformers ...) and force transmission (anti roll bar, damper, ...) These assemblies are exposed to high static and fatigue loads during normal service.
Semi Structural assembly	A semi structural assembly is by definition a non-structural connection subject only to static loads during normal operating service of the rolling stock.
Fastening assembly	A fastening assembly is not subject to static or fatigue loads during normal operating service of the stock. Is used for lining, interior fitting, signboards, ... The loosening of the connection does not lead to any dangerous situation for the user. The fastening assemblies are mainly associated to a low safety level.
Permanent or quasi permanent assembly	Assembly rarely disassembled (twice during rolling stock life), at mid-life (15 years) or in case of accident
Screw influence diameter: D_a	Exterior diameter of disk materializing contact zone between 2 assembled parts and which center is screw axis (Rötscher cone)
Clamping thickness: L_k	For bolted assemblies, it consists in sum of parts thickness located between screw head bottom and nut bottom (beginning of tapping in case of screwed assembly)
Tapping or nut implantation length: L_i	Engagement length of the threads in an internal thread or length of the screw/nut contact.
Thread pitch, p	The pitch value is the distance covered in one turn and is measured between two vertices of the thread
Nominal preload: F_0	Load or pre-stress inserted into assembly corresponding to average friction coefficient and to average tightening torque
Maximum preload: F_{0max}	Load or pre-stress inserted into assembly corresponding to minimum friction coefficient and to maximum tightening torque
Minimum preload: F_{0min}	Load or pre-stress inserted into assembly corresponding to maximum friction coefficient and to minimum tightening torque
Minimum preload stabilized: $F_{0min_{stab}}$	Load or pre-stress inserted into assembly after relaxation
Required limit load: Tr	Limit load to be ensured to fulfill non-slipping and non-separation conditions. Minimum load $F_{0min_{stab}}$ in the assembly must always be greater than required limit load.
Definition of the exposed areas	Z_{out} : Outside area (formerly known as Zone C) Z_{inW} : Inside area Wet (formerly known as Zone B) Z_{inD} : Inside area Dry (formerly known as Zone A)

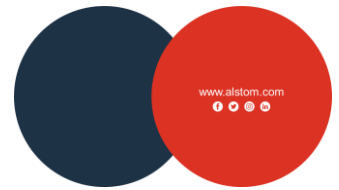

Loose fit	It's a none tight fitted assembly - Maximum relative movement of the two components depending on the gap between screw diameter and diameter of hole (see also table for size of clearance holes)
Transition fit or tight fitted	Form fit which restricts relative movement of two components (tolerances e.g. H7/j6) – is like tight fitted assembly.
ASP	Assembly Surface Protection: insertion of limited paint thicknesses or grease or specific product to optimize friction factor or only to avoid galvanic corrosion at interface
THREADED FASTENERS	
Thread forming screw or tapping screw self-threading screws	No shaves and resistant thread because the metal is pushed. (ex: used for mechanical assemblies: traction cubicle - Tarbes)
Thread cutting screw	Use for fastening: inconvenient: shavings, risk of crack initiation (ex: used for fastening signboards – Creusot)
Self-drilling screw	Screw drills the hole before forming the thread: inconvenient: shavings, machining of thread with risk of crack initiation
FLEXIBILITY	
<i>Some recommendations are given in chart form and each function is characterized by the limits to be reached. For each of the functions are associated one or several acceptance criteria (requirement requested or necessary for the implementation of the assembly), as well as the levels (quantification of the criterion on an adapted scale) with a flexibility (tolerance).</i>	
F0	The specified conditions cannot be challenged in any circumstances. The requirement must be met.
F1	The requirement is not mandatory but must be followed, unless an alternative solution can be demonstrated to be at least equivalent.

• **Size of clearance holes: F, M, L clearance holes for metric dimensions**

Screws diameter	Screw clearance holes diameter (ISO 273) for a round or oblong hole		
	F	M	L
M2	2.2	2.4	2.6
M2,5	2.7	2.9	3.1
M3	3.2	3.4	3.6
M4	4.3	4.5	4.8
M5	5.3	5.5	5.8
M6	6.4	6.6	7
M8	8.4	9	10
M10	10.5	11	12
M12	13	13.5	14.5
M16	17	17.5	18.5
M20	21	22	24
M24	25	26	28
M30	31	33	35
M36	37	39	42

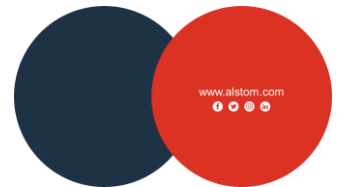

- **Size of clearance holes: for imperial dimensions**

Screw diameter	Screw clearance holes diameter (ASME B18.2.8) for a round or oblong hole		
	Close Fit	Normal Fit	Loose Fit
#4	0.120	0.128	0.144
#6	0.154	0.170	0.185
#8	0.180	0.196	0.213
#10	0.206	0.221	0.238
1/4"	0.266	0.281	0.297
5/16"	0.328	0.344	0.359
3/8"	0.391	0.406	0.422
1/2"	0.531	0.562	0.609
5/8"	0.656	0.688	0.734
3/4"	0.781	0.812	0.906
1"	1.031	1.094	1.156

- **Recommended clearance holes, compatible for imperial and metric screws**

In all cases, a stack-up analysis (cumulative tolerances) with both screw sizes shall be calculated to ensure interchangeability.

Screws diameters		Screw clearance hole diameters based on ISO 273 for a round or oblong hole (mm)		
Metric	Imperial	F	M	L
M3	#4	3,2	3,4	3,6
M4	#6	4,3	4,5	
M5	#10	5,3	5,5	5,8
M6	1/4"			7
M8	5/16"	8,4	9	
M10	3/8"	10,5	11	
M12	1/2"		13,5	14,5
M16	5/8"		17,5	18,5
M20	3/4"	21	22	
M24	1"			28



4. ASSEMBLY CLASSIFICATION

Every railway bolted assembly is defined by a safety level (/H /M /L) and a performance class (CP).

A safety level does not imply a class of performance of tightening. If necessary, industrial department can adapt the tool for tightening according to a safety level while respecting the performance class defined by the engineering office.

4.1. BOLTED ASSEMBLY SAFETY LEVEL

The 3 safety levels (High, Medium or Low – DTRF 150212) of an assembly define:

Assembly safety level	High (H)	Medium (M)	Low (L)
Calculation of the assembly and formalization	Mandatory		Optional
Assembly and inspection requirements	DTRF 150214		
Sourcing prescriptions of fastening elements	DTRF 150213		

4.2. BOLTED ASSEMBLY PERFORMANCE CLASS

A screwed assembly is designated by a performance class (CP) defined by the engineering office, determined according to the constraints related to tightening precision required by dimensioning, accessibility of the assembly and during the maintenance.

The 5 performance classes used within ALSTOM define the maximum precision required for the use of a tension or torque applied to an assembly by considering tool precision **as well as human factor**:

- +/-20 % precision tools are not appropriate for a CPC20 performance class.
- Capability (as per DTRF 150214) allows verifying the adequacy of means (sensitivity) considering the human factor towards the specified performance class.
- CPC20 torque values considered as a preferred solutions for all designs.

Assembly Performance Class	Tightening method	Maximum precision required	Tightening tool example	Assembly and inspection requirements
CP B	Tension	$< \pm 10\%$	Hydraulic tensioner - Fusible HRC screw	DTRF 150214
CP C10	Torque	$< \pm 10\%$	Torque tightening (wrench)	
CP C20		$< \pm 20\%$		
CP D		NA	Tightening without the use of a torque wrench (flat wrench)	

5. DELIVERABLES

5.1. ASSEMBLY DESCRIPTION

- Indicate the DTR code of the fixation element in the bill of material
- Prescribe salt spray level, in hours, if different from standards DTRF 150213
- Use the logos of the DTRF 150250 to specify:
 - Tightening torque value and performance class
 - Safety level (/H / M / L)
 - Safety logo
 - Geometrical tolerances on interfaces (hole, flatness, roughness)
 - Additional protection on fastener (wax, peripheral sealing)

5.2. ADDITIONAL INFORMATION

- Retightening operation with parameter defined with the site assembly expert (ENG/IND): duration + retightening torque (if different from initial torque value):
Example Re-tightening following DTRF 150214 - 250N.m CPC20 after 24 hours
- When using grease prescribe grease with Molybdenum (do not prescribe oil or anticorrosive grease)
- Indicate if it is necessary to use thread lock and the type
- Authorization of the tightening head side: only in the case of a screwed assembly, in case of difficult access, specify the possibility of tight head side (by default the DTRF 150214 specifies the tightening nut side)
- Authorization to not mark the elements (blue, orange or green) according to the limits of the DTRF 150214: contact with effluent, difficulty of access, ...
- List of screw whose Tr level is $> 70\%^*$ of $F_{0min_{stab}}$ (*this list is used for the control plan defined into DTRF150214*).

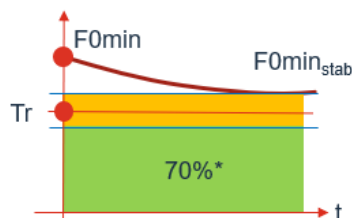















6. MECHANICAL FASTENERS LIST

6.1. AUTHORIZED AND STANDARDIZED FASTENERS

PPLs (Preferred Part Lists) are built with these fasteners which are to be preferentially used. PPPLs (Project Preferred Parts Lists) are built with this PPLs and project specificities.













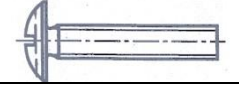

6.1.1 AUTHORIZED AND STANDARDIZED SCREWS

Authorized and standardized screws (PPLs)		
 <p>Entirely threaded H screws</p>	 <p>Bolt</p>	 <p>Tension control bolt (capped head)</p>
 <p>Hexagonal socket head cap</p>	 <p>Hexalobular socket flat countersunk head screw</p>	 <p>HRC Stud</p>
 <p>Stud with rolled thread</p>	 <p>Hexalobular screw for steel sheet</p>	 <p>Screw for wood (hexalobular)</p>
 <p>Thread forming screw</p>	 <p>Screw flat end or socket</p>	 <p>Hexagonal socket flat countersunk head screw</p>
 <p>Hexagonal socket button head</p>	 <p>Tamper proof - Torx (countersunk with central plot)</p>	 <p>Partially threaded H screws (ISO4014) (a)(b)</p>

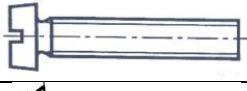
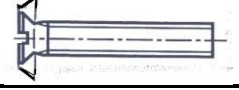
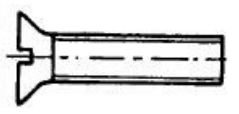



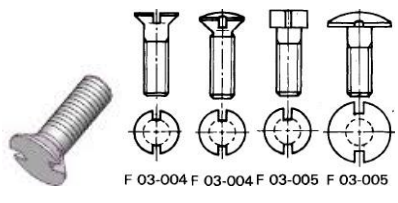

The authorization to use hexalobular (Torx) is managed through the PPL.

(a) Authorized under condition of required towards fatigue holding and shear

(b) For NAM market







Conventional elements		Systematically replaced by
	Slotted pan head (CLS) screw	 or  TORX
	Single-slotted truss head (RL S) screws 1ft	
	Double-slotted truss head (RL S) screws 2ft	
	CBHC Screw	
	Hexagonal socket head cap (HSC) screw, <u>low head</u>	
	Torx plus screw (socket type or not)	
	Slotted cheese head (CS & SZ) screw	
	lotted flat countersunk head (F S) screw + conical washer	
	Slotted flat countersunk head (FS) screw	
	Cross recessed flat countersunk head (F Z) Philips or Pozidriv screw	
	Socket flat countersunk head or bombed head screw for wood pozidrive or philipps	Screw for wood FX or BX, (hexalobular)  TORX
	Notched screw	 Tamper proof - Torx (countersunk with central plot)

6.1.2 AUTHORIZED AND STANDARDIZED NUTS

Authorized and standardized nuts (PPLs)		
 H (usual)	 Locknut with plastic insert (c) H lock PLAST	 Cage nut
 Insert Keensert (a)	 Crimping nut with an open hexagonal barrel (b)	 Insert for wood

- (a) For structural application
- (b) For retrofit, use the broaching tool to mount hexagonal insert.
- (c) For mechanical and electrical application. For electrical application for $d \leq M5$.

6.1.3 AUTHORIZED AND STANDARDIZED WASHERS

Authorized and standardized washers (PPLs)		
 Conical striated CS	 Wedge-lock washer (Flat version) (a)(c)	 Washer NSK
 Plain washer (c)	 TREP	 conical smooth washer (b)

- (a) Preferentially on screwed assemblies and for bolting assemblies access required to the screw head side to hold it in position during tightening. To not associate a ramp washer with a flat washer that is not locked against rotation. The hardness of the material under the washer must be ≤ 200 HV.
- (b) For NAM market - authorized under condition, for fatigue holding and shear
- (c) Does not work for settlement control (relaxation due to several layer, paint thickness, ...)

6.1.4 NON-STANDARDIZED FASTENERS

To limit the number of references (rationalization), the authorization for implementing this type of element is only granted if:

- The quantity is justified
- Extension of existing solution
- Validation of the single-source aspect (if applicable).
- Agreement from maintenance (management of variants).

These fasteners are not included into the PPL and an authorization based on solid reason, can be given by local assembly expert to be included into a 3PL.

Authorized under condition, restricted use		
 <p>Screw with integrated washer</p>	 <p>Tab washer (a)</p>	 <p>Hexagonal castellated nut – engaging or non engaging (b)</p>
 <p>Hexagon bolts with flange (g)</p>	 <p>H screw with flange or captive washer (conical or flat)</p>	 <p>Tension nut</p>
 <p>Thin nut class 04 (d)</p>	 <p>conical smooth washer (c)</p>	 <p>Ramp washer with internal plastic ring (j)</p>
 <p>VS (f)</p>	 <p>Verbus ripp screw or nut (e)</p>	 <p>Cap nut</p>

Authorized under condition, restricted use		
Square head screw (c)	Wing nut	Thread cutting screw
Tension control bolt (hexagonal head)	Panhead screw (with 6 internal lobes)	Square collar screw or carriage bolt
Screw FHC steel 8.8	Crimping nut with a closed hexagonal barrel	Steel welding nut (grade 06) or stainless steel
Insert helicoil (h)	VARGAL nut (i)	Locknut: Double-slotted (a)
Locknut: FS Nut	Clip nut	









- (a) Against loss – for structural application (bogies, CBS link) and electrical application and $d > M5$
- (b) For historical application on component (like bogies): example conical smooth for assemblies with paper joint
- (c) Authorized under condition of required towards fatigue holding and shear
- (d) Authorized for counter nut solution
- (e) Forbidden on soft surface or painted – authorized for German projects
- (f) Preferentially for bolting assembly, with high shear load
- (g) In link with ramp washer (see chapter washer combination)
- (h) Limitation of use for fitting application or repair
- (i) Only for specific application with high vibration and validated by product qualification
- (j) Authorized with technico-economic documentary evidence, industrial and logistic.

6.2. PROHIBITED FASTENERS

Fasteners listed in this section are not to be used on new projects.

This list was built on negative return of experience of these fasteners (not efficient fasteners or impacts on safety or maintenance) but also to reduce the number of fasteners solutions (rationalization).

6.2.1 PROHIBITED SCREWS

Prohibited screws		
 HSC cap screw - low head	 LP assembly system	 Self-drilling screws
 Duo taptite screw with threading	 Machined threaded stud	 Huck 360° System
 Precoat screw (a)	 Pre grease screw or nut - Dry coating with integrated lubricating (b)	 Bolt fabricated from threaded rods and welded nut









- a) Derogation possible based on a technico-economic documentary evidence, linked to quantities, industrial and logistic: Precoat links to high logistic constraints bounds to respect of best before dates and storage conditions
- b) Derogation possible based on a technico-economic documentary evidence, industrial and logistic. Due to high friction factor dispersion only to use after validating the performance class and specific tightening torque (product qualification).

6.2.2 PROHIBITED NUTS

Prohibited nuts		
 <p>Spirallock tapping</p>	 <p>FRENVIS nut</p>	 <p>Single-slotted HFR nut</p>
 <p>Square nut</p>	 <p>Deformed HFR nut (oval), all metal</p>	 <p>Spyrallock nut</p>
 <p>Nordlock nut</p>	 <p>HFR nut with metallic insert (AMELOCK, ...)</p>	 <p>Tensilock nut (toothed)</p>
 <p>Self tapping insert (Ensats, ...) (b)</p>	 <p>Blind rivet nut or stud, knurled or plain body (a) with cylindrical shank</p>	 <p>Cold-forming tap (EMUGE) (b)</p>
 <p>Crimped nut or stud</p>	 <p>Blind rivet nut, hexagonal shank with underhead seal ring</p>	 <p>Blind rivet nut, hexagonal shank with underhaed seal precote</p>

- (a) Authorized when required by Project Contract (NAM) or for assemblies never dismount during maintenance.
 (b) Forbidden because need a precise drilling tolerance.

6.2.3 PROHIBITED WASHERS

Prohibited washers		
 Spring locks washer (c)	 Onduflex washer	 Fan washer (b)
 Ripp lock washer	 Ramp washer with plastic ring outside (d)	 Wedge-lock washer - Conical version (a)
 Internal tooth lock washer	 Toothed lock washer	 Cup washer

- (a) Example X serie from Nordlock - Rationalization on flat wedge-lock washers only
- (b) Usable in dispensation, to respect the standard "hydraulic wedging for wheels" used by le Creusot
- (c) Authorized spring locks when required by Project Contract (NAM)
- (d) Forbidden due to rationalization reason and weakness against corrosion in highly exposed areas.

7. LIMITATIONS ON STANDARDIZED FASTENERS

7.1. LIMITATIONS ON DIAMETER AND MATERIAL

7.1.1 METRIC DIAMETERS

	M2	M2,5	M3	M4	M5	M6	M8	M10	M12	M14*	M16	M18*	M20	M22*	M24	M30	M36	M39	
Stainless steel	Green							Red	Red										
Zinc-plated steel	Yellow						Green			Red	Green	Red	Green	Red	Green				

(*) historical diameter, always used on standard component like dampers.

7.1.2 IMPERIAL DIAMETERS











	#4*	#6*	#8*	#10*	1/4"	5/16"	3/8"	7/16"	1/2"	9/16"	5/8"	3/4"	7/8"	1"	1-1/8"	1-1/4"	1-3/8"	1-1/2"	
Stainless steel	Green							Red	Green	Red	Green	Yellow	Red	Yellow	Red	Red	Red	Red	Red
Zinc-plated steel	Yellow				Green			Red	Green	Red	Green		Red	Green	Yellow				

(*) indicates non-structural applications - It is recommended to use 1/4" screws or above for equipment mounting or structural assemblies.

7.2. LIMITATIONS ON DIAMETER AND ELEMENT TYPES

7.2.1 METRIC DIAMETERS

Element	Type	Picture	M2 - M2,5	M3	M4	M5	M6	M8	M10	M12	M14	M16	M18	M20	M22	M24	M30	M36	M39	
			Screws	H - 8.8		Green	Green	Yellow	Green	Green	Green	Green	Green	Red	Green	Red	Green	Red	Green	Green
H - 10.9	Red	Red		Red		Red	Red	Red	Red	Red	Red	Red	Red	Red	Red	Red	Red	Red	Red	Red
H - 12.9	Red	Red		Red		Red	Red	Red	Red	Red	Red	Red	Red	Red	Red	Red	Red	Red	Red	Red
H - A2 xx	Green	Green		Yellow		Green	Green	Green	Green	Green	Green	Red	Yellow	Red	Red	Red	Red	Red	Red	Red
HRC - 10.9		Red		Red	Red	Red	Red	Red	Red	Red	Red	Green	Red	Green	Yellow	Green	Green	Green	Red	
CBHC stainless steel		Red		Red	Red	Red	Red	Red	Red	Red	Red	Red	Red	Red	Red	Red	Red	Red	Red	Red
CBX StSt + Steel		Yellow		Yellow	Yellow	Yellow	Yellow	Yellow	Yellow	Yellow	Yellow	Yellow	Yellow	Yellow	Yellow	Yellow	Yellow	Yellow	Yellow	Yellow
CBHC steel		Green		Green	Yellow	Green	Green	Green	Green	Green	Green	Red	Red	Red	Red	Red	Red	Red	Red	Red
FHC Stainless steel		Green	Green	Yellow	Green	Green	Green	Green	Green	Red	Red	Red	Red	Red	Red	Red	Red	Red	Red	

Element	Type	Picture	M2 – M2,5	M3	M4	M5	M6	M8	M10	M12	M14	M16	M18	M20	M22	M24	M30	M36	M39
			FHC Steel FX StSt + Steel																
HSC - 8.8																			
HSC - 10.9																			
HSC - 12.9																			
HSC – Stainless steel																			
Square neck bolt																			
CBX, FX, Tamper Torx (countersunk with central plot) Only carbon steel																			
HC(1)																			
Screws for steel sheet or wood																			
Screw with integrated washer, captive																			
With flange																			
Thread cutting screw																			
Thread forming screw																			
Insert	Helicoil																		

Element	Type	Picture	M2 – M2,5	M3	M4	M5	M6	M8	M10	M12	M14	M16	M18	M20	M22	M24	M30	M36	M39	
			Keensert																	
Nuts	H nut																			
	Locknut double slotted																			
	FS																			
	Locknut with plastic insert																			
	Hexagonal blind rivet nut open (2)																			
	Welded nut																			
	Cage nut																			
	Cap nut																			
	Wing nut																			
	Tension nut																			
	Washers	CS																		
Flat (thick included)																				
NSK																				

Element	Type	Picture	M2 – M2,5	M3	M4	M5	M6	M8	M10	M12	M14	M16	M18	M20	M22	M24	M30	M36	M39	
	TREP																			
	Wedge lock washer (flat)																			
	Wedge lock washer (flat) with elastic ring inside (3)																			
	VS																			

- (1) Carbon Steel Hexagon Socket Set Screws are not to be preloaded in tension.
- (2) Authorized for historical electrical application in M12 size (isolator) even it's red marked for rationalization on new project.
- (3) Only available on the market M8-M16.

7.2.2 IMPERIAL DIAMETERS

Element	Type	Picture	#4	#6	#8	#10	1/4"	5/16	3/8"	7/16	1/2"	9/16	5/8"	3/4"	7/8"	1"	1-	1-	1-	1-		
Screws	H – SAE Grade 5																					
	H – SAE Grade 8																					
	H – ASTM F593																					
	Machine Screw – No Grade FLZ CLZ RLZ																					
	HRC																					
	HSB stainless steel ASTM F879																					
	HSB Alloy Steel ASTM F835																					
	HSF Stainless steel ASTM F879																					
	HSF Alloy Steel ASTM F835																					
	HSC – Alloy Steel ASTM A574																					

Element	Type	Picture	#4	#6	#8	#10	1/4"	5/16	3/8"	7/16	1/2"	9/16	5/8"	3/4"	7/8"	1"	1-	1-	1-	1-
	HSC – Stainless steel ASTM F837		Green	Green	Green	Green	Green	Green	Green	Red	Green	Red	Green	Green	Red	Yellow	Red	Red	Red	Red
	Square neck bolt		Red	Red	Red	Red	Yellow	Red	Red	Red	Red	Red	Red	Red	Red	Red	Red	Red	Red	Red
	HSBP		Red	Yellow	Yellow	Yellow	Red	Red	Red	Red	Red	Red	Red	Red	Red	Red	Red	Red	Red	Red
	HSFP		Red	Yellow	Yellow	Yellow	Red	Red	Red	Red	Red	Red	Red	Red	Red	Red	Red	Red	Red	Red
	HSS ⁽¹⁾		Green	Green	Green	Green	Green	Green	Green	Red	Red	Red	Red	Red	Red	Red	Red	Red	Red	Red
	Screws for steel sheet or wood		Red	Yellow	Yellow	Yellow	Yellow	Red	Red	Red	Red	Red	Red	Red	Red	Red	Red	Red	Red	Red
	Screw with integrated washer, captive		Yellow	Yellow	Yellow	Yellow	Yellow	Red	Red	Red	Red	Red	Red	Red	Red	Red	Red	Red	Red	Red
	With flange		Red	Red	Red	Red	Red	Yellow	Yellow	Red	Yellow	Red	Yellow	Yellow	Red	Yellow	Red	Red	Red	Red
Insert	Helicoil		Red	Yellow	Yellow	Yellow	Yellow	Red	Red	Red	Red	Red	Red	Red	Red	Red	Red	Red	Red	Red
	Keensert		Red	Red	Yellow	Yellow	Green	Green	Green	Red	Green	Red	Yellow	Red	Red	Red	Red	Red	Red	Red
Nuts	H		Green	Green	Green	Green	Green	Green	Green	Red	Green	Red	Green	Green	Red	Green	Green	Green	Green	Green
	H LOCK METAL		Yellow	Yellow	Yellow	Yellow	Yellow	Yellow	Yellow	Red	Yellow	Red	Yellow	Yellow	Red	Yellow	Yellow	Yellow	Yellow	Yellow
	H LOCK PLAST ⁽²⁾		Green	Green	Green	Green	Green	Green	Green	Red	Green	Red	Green	Yellow	Red	Yellow	Red	Red	Red	Red
	Hexagonal rivet nut Thin head, CS		Red	Red	Red	Red	Red	Red	Red	Red	Red	Red	Red	Red	Red	Red	Red	Red	Red	Red

Element	Type	Picture	#4	#6	#8	#10	1/4"	5/16	3/8"	7/16	1/2"	9/16	5/8"	3/4"	7/8"	1"	1-	1-	1-	1-
	Hexagonal rivet nut Thin head, SS		Red	Yellow	Yellow	Yellow	Yellow	Yellow	Yellow	Red	Red	Red	Red	Red	Red	Red	Red	Red	Red	Red
	Hexagonal rivet nut Flush head, CS		Red	Green	Green	Green	Green	Green	Green	Red	Red	Red	Red	Red	Red	Red	Red	Red	Red	Red
	Hexagonal rivet nut Flush head, SS		Red	Red	Red	Yellow	Yellow	Yellow	Yellow	Red	Red	Red	Red	Red	Red	Red	Red	Red	Red	Red
	Welded nut		Red	Yellow	Yellow	Yellow	Yellow	Yellow	Yellow	Red	Red	Red	Red	Red	Red	Red	Red	Red	Red	Red
	Cage nut, CS		Red	Yellow	Yellow	Yellow	Yellow	Yellow	Yellow	Red	Red	Red	Red	Red	Red	Red	Red	Red	Red	Red
	Cage Nut, SS		Red	Red	Red	Yellow	Yellow	Yellow	Yellow	Red	Red	Red	Red	Red	Red	Red	Red	Red	Red	Red
	Acorn nut		Yellow	Yellow	Yellow	Yellow	Yellow	Yellow	Yellow	Red	Red	Red	Red	Red	Red	Red	Red	Red	Red	Red
	Wing nut		Yellow	Yellow	Yellow	Yellow	Yellow	Yellow	Yellow	Red	Red	Red	Red	Red	Red	Red	Red	Red	Red	Red
	Tension nut		Red	Red	Red	Red	Red	Red	Red	Red	Red	Red	Red	Red	Red	Red	Red	Red	Red	Red
Washers	C washer		Red	Yellow	Yellow	Yellow	Green	Green	Green	Red	Green	Red	Green	Green	Red	Green	Red	Red	Red	Red
	PLAIN		Green	Green	Green	Green	Green	Green	Green	Red	Green	Red	Green	Green	Red	Green	Green	Green	Green	Green
	HRDN		Red	Red	Red	Red	Yellow	Yellow	Yellow	Red	Green	Red	Green	Green	Red	Green	Green	Green	Green	Green
	RAMP		Red	Red	Red	Yellow	Green	Green	Green	Red	Green	Red	Green	Green	Red	Green	Yellow	Yellow	Yellow	Yellow
	SPRING ⁽³⁾		Yellow	Yellow	Yellow	Yellow	Yellow	Yellow	Yellow	Red	Yellow	Red	Yellow	Yellow	Red	Yellow	Red	Red	Red	Red

- (1) Carbon Steel Hexagon Socket Set Screws are not to be preloaded in tension.
- (2) When zinc flake plating is required, Carbon Steel Locknuts with Plastic Inserts shall not have plastic inserts installed during the plating process.
- (3) Use spring locks when required by Project Contract.



7.3. LIMITATIONS ON SCREW LENGTHS

Limitation for screws lengths is to be respected according to the PPLs. Regarding length thread of screw, fully threaded screws to be preferentially used except if stress under fatigue requires the use of partially threaded screws or long assemblies (example: $L_k > 5d$).

7.4. LIMITATIONS ON FASTENERS DEPENDING ON REGIONS

Restrictions on element types depending on areas are to be respected according to PPLs.



8. DESIGN RULES

8.1. SELECTION AND ASSOCIATION RULES

8.1.1 SELECTION ACCORDING TO ZONES

Diameter	Zones		
	Z _{inD} (Inside dry area)	Z _{inW} (Interior wet area)	Z _{out} (outside)
≤ M6 or ≤ 1/4"	Stainless steel	Stainless steel or carbon steel if galvanic incompatibility	
≥ M8 or ≥ 5/16"	Carbon steel	Carbon steel*	

(*) Additional protection, decoupling if issues with galvanic compatibility with the assembled materials.

8.1.2 ASSOCIATIONS RULES FOLLOWING MECHANICAL CHARACTERISTICS

Metric units

Screw grade	Washer minimum hardness *	Nut quality class
8.8	200 HV	8
10.9	300 HV	10
12.9	420 HV	12
A2 70	200 HV	A2 70**
A4 80	200 HV	A4 80

(*) as per DTRF 150213

(**) or some HFR nut in A4-80 (with the Torque value for 70 quality class in line with the screw)

Imperial units







Screw grade	Washer	Nut grade
SAE J429 Grade 5	ASME B18.21.1	SAE J995 Grade 5
SAE J429 Grade 8	ASTM F436	SAE J995 Grade 8
ASTM F593 CW	ASME B18.21.1	ASTM F594 CW

In the design, it is prohibited to:

- Mix screws or nuts of different quality classes and washer hardness's on output from engineering office.

8.1.3 ASSOCIATION RULES ABOUT WASHER

- Combinations of washers to use versus the holes size (mechanicals applications):

	Round (R) or oblong (O) hole	Part treatment	Steel support ** Size of clearance hole	
			F or M Close or Normal Fit	L Loose Fit
 Plain washer	R	Painted or unpainted part or with ASP	Regular Plain	
 NSK	R or O		NSK-M	NSK-M + large flat washer*
 CS	R	Unpainted part	Large CS	
	O	Painted part or with ASP	Large CS + large flat washer*	
 VS	R	Unpainted part or with ASP	VS	
 Spring lock washer****	R	Painted or unpainted part or with ASP	Regular Plain+ Spring	Wide Plain + Spring
	O			
 C	R	Unpainted	C	C + wide plain washer*
	O	Painted part or with ASP	C + regular plain washer	
 Wedge lock washer - large series	R	Unpainted part or with ASP	Ramps washers large series	
	O		Forbidden ***	

ASP = Assembly Surface Protection

(*): if the stiffness of the large flat washer is insufficient, or if problems arise when purchasing washers following standard (thick washer), it is possible to insert a special washer under the wide CS, as per the drawing with a hardness compatible with the screw quality class and whose thickness $\geq 0.5 d$.

(**) on soft material, such as aluminum, take a wide washer (wide CS or wedge lock washer).

For mechanical use only (not electrical) note that thick flat washers are not used, since they are difficult to source.

(***) solution for previous projects: Large ramps lock washer + screw with flange

(****) Use spring locks when required by Project Contract.

8.1.4 DESIGN RULES

- Use for a single fixing point where several screws or bolts are used (screw and nut), the same diameter and the same quality class for all elements at the fixing point.
- For adjustment areas, which require re-assembly, in order to avoid replacement of fasteners, it is requested to use flat washers and H-nuts which can be re-used according to the table of re-use of fasteners in DTRF 150214.
- Use the preferred solutions described in the table below:

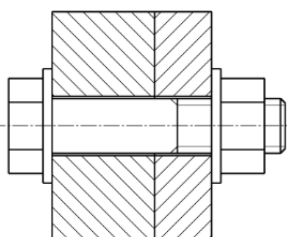
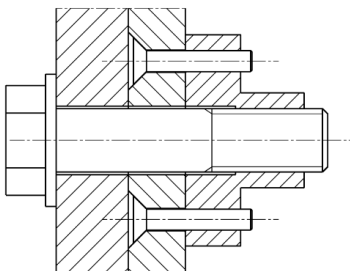
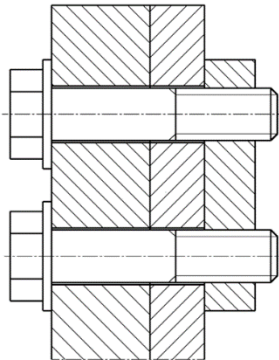
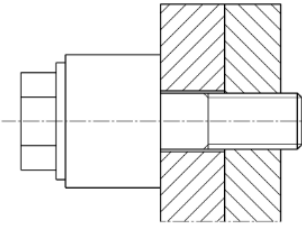
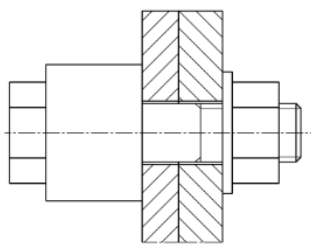
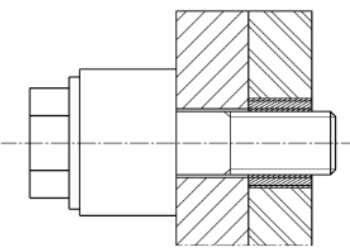
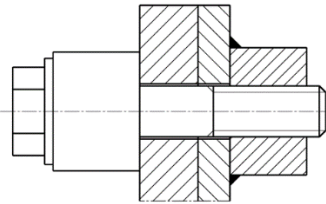
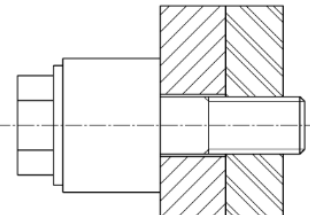
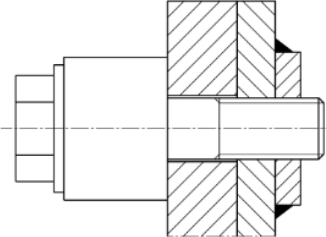
Preferred solution	Solution authorized under condition	Prohibited solution
 Use of a nut (both side accessible)	  Use of replaceable threaded plate	 Tapping directly in the main structure
 For thin layer use a spacer below the head to increase the clamp length	 Tapping in soft material (e.g., aluminum) with insert	 Use of no replaceable threaded plate
		 Tapping in soft material without insert
		

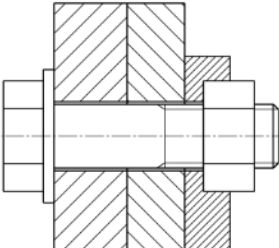
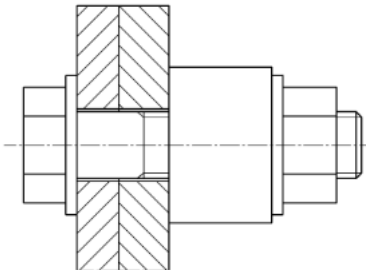
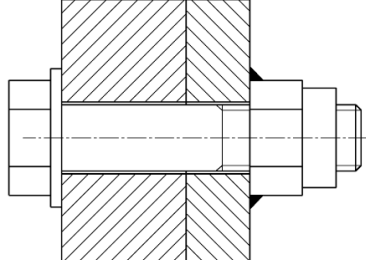
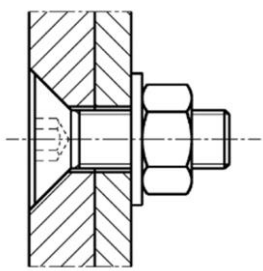
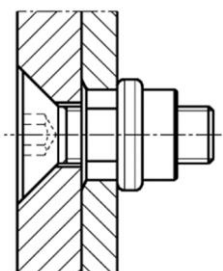
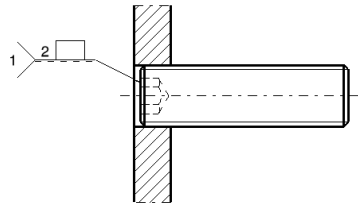
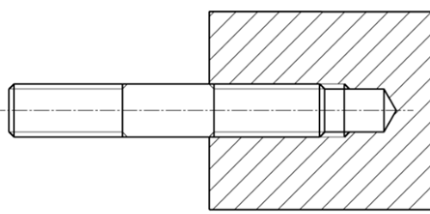
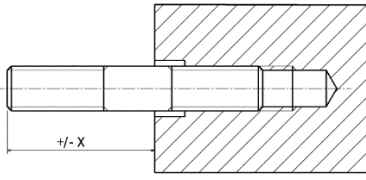
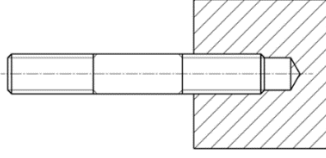
Preferred solution	Solution authorized under condition	Prohibited solution
 <p>Use of a nut blocked in rotation (one side accessible only for tightening)</p>	 <p>Spacer not blocked into rotation, on the nut side if validated by indus</p>	 <p>Tapping between two parts</p> <p>Welded nut or locknut</p>
 <p>Screw countersunk head with nut</p>		 <p>Screw countersunk head with rivet nut, cage nut or welded nut</p>
		 <p>Screw flat end or socket welded into thin sheet</p>
 <p>Stud properly implemented</p>	 <p>Implementation with adjustment (e.g., risk of collision)</p>	 <p>Stud bottoming out in threaded hole</p>

Protruding thread length (b), unused thread length (c) and edge distance (e) must respect following limits, exceptions permitted for economic, availability (per PPL) or clearance reasons.

- $b \geq 3p$ for L_{kmax} ,
- $b \leq 10p$,
- $c \geq 6p$,
- $e \geq 1.5d$
- L_i validated by calculation team.
- L_{kmin} Clamp length:

	$L_{k \min}$
Structural assembly	$>3d$
Semi structural assembly	$>1d$
Fastening assembly	$>0,5d$

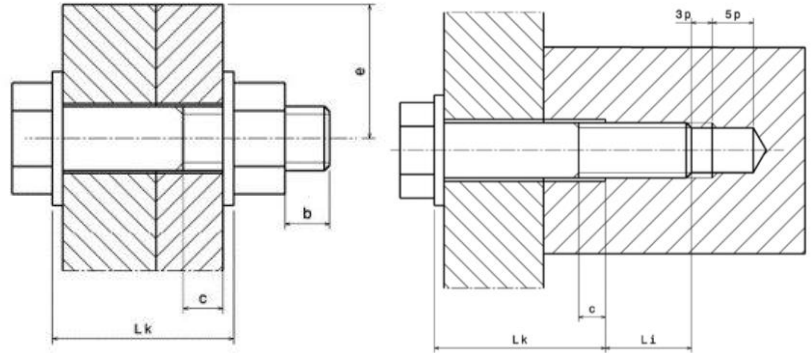

Thread-lock

- Thread-lock is used to prevent loss and not to prevent loosening.
- The design should be made to avoid the use of thread-locker as much as possible.
- Applicable for all diameters and only according to the following cases:

Disassembly	Settlement	Nut typ	Washer typ	Thread-lock	
				Stainless steel hardware	Carbon steel hardware
Bolted or screwed assembly frequently disassembled during maintenance	Prohibited				
Bolted or screwed assembly not disassembled during maintenance	with re-tightening	Prohibited			
	without re-tightening	Tapping, H nut, crimp nut with hexagonal barrel	wedge-lock washer or collapsible washer	Not permitted*	Not necessary
		Locknut, cage nut, insert (Keensert or Helicoil)	Flat washer, CS, VS		Medium thread-locker
			any washer		Prohibited

(*) except for the fitting of small stainless-steel screws tightened without lubrication see chapter torque table.

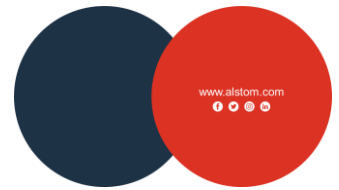

8.2. FASTENER ADDITIONAL PROTECTION AFTER ASSEMBLY

- If the assembly is visible with aesthetic requirements, it is mandatory to adapt the fastener type (color, material, geometry, ...)
- If the assembly is visible **without any aesthetic requirement**, it is necessary to protect fastener bought following DTRF 150213 from corrosion with an additional protection following the below table (formalization following DTRF150250 – DADI). The reference of the proper additional protection (in accordance with surface protection catalogue DTRF150611), depending on the constraints of the manufacturing process is defined by the industrialization in instruction sheets.

				Zones						
				Z _{inD}			Z _{inW}			Z _{out} *
				Exposure to cleaning agents according to DTRF 150262						
Material	Family DTRF 150213	Disassembly frequency	Visible assembly without aesthetic requirement	Unexposed	C1 or C2 diluted	C3 or C2 non diluted	Unexposed	C1 or C2 diluted	C3 or C2 non diluted	All exposures
Stainless steel	C / D	D / ND	V / NV	0	0	0	0	0	0	0
Zinc-platted steel	A	D / ND	NV	0	0	2	0	0	2	2
		D	V	0	1	1	0	1	1	1
		ND	V	0	2	2	0	2	2	2
	B / D**	D / ND	NV	0	2	2	2	2	2	2
		D	V	0	1	1	1	1	1	1
		ND	V	0	2	2	2	2	2	2

(*) with or without exposure on UV radiation

(**) D includes pins and studs

D: Disassembled frequently in maintenance

ND: Not disassembled frequently in maintenance (at midlife or never)

V: Visible assembly

NV: Assembly not visible

0	Additional protection not required
1	Additional protection not permanent (wax,...)
2	Permanent additional protection (varnish, paint, ...)

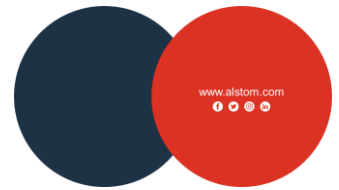

9. FUNDAMENTAL DIMENSIONING CRITERIA

9.1. ASSEMBLY DIMENSIONING

<i>Utilization constraints</i>	<i>Criterion</i>	<i>Level</i>	<i>Flexibility</i>
Resistance under axial load: exploitation (exceptional and service) and proof load	Axial load	No separation	F0
Resistance under transversal load in service conditions	Shear load	No sliding	F0
Resistance under transversal load in proof load conditions	Shear load	No sliding*	F1
Dimensioning of the mechanical stop (example of a pin if the screws used cannot absorb the shear load)	No shearing of the dowel	Under Proof Load	F0
	Tolerance at shearing dowel level	Enough to ensure non-contact with the fastener shaft	F0
	No peening of the dowel or the boring	Under Proof Load	F0
Shear stress directly absorbed by a screw		Prohibited	F0
All the criteria must be inside of the elastic domain:			
Utilization rate on tightened bolt at installation stage	Yield	90% +/- 3%	F0
Utilization rate on tightened bolt during exploitation	Yield	100%	F0

(*) In case of exceptional loads sliding may be accepted if the sliding distance is limited:

- By a transition fit for load transferring interfaces (e.g. pivot, articulation)
 - tolerance of form fit < limit displacement
 - proof of bending stress in bolt / fit tolerance
 - proof of form fit (see dimensioning of the mechanical stop)
 - proof of full functionality retained
 - locking device against self-loosening by rotation
- By a loose fit for e.g. equipment fixation or one directional loads (e.g. steps, slinging hook)
 - proof of shear resistance and bearing
 - proof of form fit
 - limit displacement by hole size (m or f) or the bolt resilience



Design criterion for mechanical screwed assemblies inside an electrical box of equipment (traction block or box, LV cabinet, switch gear, etc.) whose safety level is:

- High: dimensioning is performed by following the instructions of the previous table.
- Medium or low: dimensioning may be performed according to EN 1993-8 (calculation based on the shear failure limit of the screw)

Design criterion for an anti-fall device:

- Primary fastener according to the requirements of the previous table
- Fastening of anti-fall device or second loading path, may be performed with the following criteria:
 - Separation and slippage possible
 - No rupture of the fastener.

9.2. OPTIMIZATION RULES FOR BOLTED ASSEMBLIES

By order of priority:

1. Increase the clamping length
2. Increase number of screws in order to decrease the preload required into each screw
3. Increase screw diameter in order to increase minimum preload F_{Omin}
4. Increase bolt grade in order to increase minimum preload F_{Omin}
5. Increase shear force capacity using improved friction factor at interface
6. Increase performance class (CP) in order to increase minimum preload F_{Omin}
7. Optimize the torque value (by calculation or test)*
8. Specify retightening operation
9. Lubricate the screw or the nut in order to increase minimum preload with manufacturing validation (in that case, contact the Site Assembly Expert).

(*) About torque value, the rule is always to use the standard tightening torques. Only in the following cases, can the assembly be optimized (tension reached) by a specific torque value (nonstandard value). Please note that this specific torque must be as close as possible to the rounding table of the standard tightening means (otherwise industrial validation is required):

- Use 90% of the yield point if standard torque value is using a below value for standardization purpose
- Assembly having been the subject of a product qualification considering serial part (rigidity of the real assembly, bearing limitation, ...) or special elements (hammer screw, washer or nut) different from the preferred part list.
- Tightening on the head side (ex: case of screws with flange) and not the nut side.
- Use of washers or nuts different from the torques reference tables
- Tightening into a soft thread (specific friction factor or limitation related to the type of insert)
- Tightening on non-metallic part (plastic, composite, ...)



10. TORQUE TIGHTENING VALUES

Application of the standard torque tightening values:

- to be used preferentially and as input for the calculation of a connection
- for CPC20 and CPC10 and several different type of fastener
- for friction factor according to DTRF150213.
- Torque to be applied on the nut side; torque application on the head side must be validated by the site bolting expert.
- Torque also applicable for threaded hole after validation of the friction factor by the site bolting expert.

Hypothesis taken for the definition of the standard torque tightening values:

- Step 1: equivalent stress at installation stage = 90% +/- 3% of the Yield of the screw
- Step 2: values are rounded relation to the capacity of standard tools

Rounding table for metric values	
Torque range (N.m)	Rounding value (N.m)
0 - 10	0.5
10 - 50	2
50 - 100	5
100 - 400	10
400 - 1000	20
> 1000	50

Rounding table for imperial values	
Torque range	Rounding value
0 in-lbf - 50 in-lbf	0.5 in-lbf
50 in-lbf - 120 in-lbf	1.0 in-lbf
10 ft-lbf - 100 ft-lbf	0.5 ft-lbf
100 ft-lbf - 150 ft-lbf	1.0 ft-lbf
150 ft-lbf - 250 ft-lbf	2.0 ft-lbf
250 ft-lbf - 1000 ft-lbf	5.0 ft-lbf
> 1000 ft-lbf	10.0 ft-lbf





- Step 3: rounding for a same diameter if proximity between 2 different fastening solution.

Do not use these standard torque tightening values if the fastener type (bolt with flange, washer with grooves, ...) or friction factors are different from the ones mentioned in the tables.



10.1. STANDARD TORQUE VALUES FOR NUT – CP C20

10.1.1 STANDARD TORQUE VALUES FOR METRIC NUT – CP C20

BOBA reference : T1-150210P										
Tightening torque values in Nm for Metric screws / Tightening performance class: CP20 Screw diameter with torque values in <i>italic</i> are not standard and should be avoided										
Fastener	H and HSC screws									
	CS washers and flat washers									
	 Hexagonal nut, Self-locking nut with plastic insert			 All metal lock nut FS & double slotted						
Friction	Friction factor head and threads: $\mu_{ave} = 0.15 \pm 0.03$			Head and threads: $\mu_{ave} = 0.275 \pm 0.075$ (dry) Head and threads: $\mu_{ave} = 0.16 \pm 0.04$ (Lubr)		Friction factor Head: $\mu_{ave} = 0.15 \pm 0.03$ Threads: $\mu_{ave} = 0.19 \pm 0.03$			Head: $\mu_{ave} = 0.275 \pm 0.075$ Threads: $\mu_{ave} = 0.315 \pm 0.075$ (dry) Head: $\mu_{ave} = 0.16 \pm 0.04$ Threads: $\mu_{ave} = 0.2 \pm 0.04$ (lubr)	
	Class	8.8	10.9	12.9	A2 or A4 - 70	A2 or A4 - 80	8.8	10.9	12.9	A2 or A4 - 70
3	1	1.5		Same as 8.8 quality class torques values	1 (*)	← Torque identical to H nut (*)				
4	2.5	3.5			3 (*)					
5	5	7			6.5 (*)					
6	8.5	12	14	6	8	← Torque identical to H nut			← Torque identical to H nut	
8	20	30	36	14	20				16	20
10	42	60	70	28	38				30	40
12	70	100	120	50	65				50	70
(14)	110	160	190	80	100				120	170
16	170	250	290	120	160	180	270	320	130	170
(18)	240	350	420	170	220	260	370	440	180	240
20	340	500	580	230	310	370	520	620	250	340
(22)	480	680	780			500	720	840		
24	600	840	980			640	900	1050		
(27)	880	1250	1450			940	1350	1550		
30	1200	1700	2000			1300	1800	2150		
36	2100	2950	3450			2250	3150	3700		

(*) Stainless steel fasteners smaller than 6 mm are assembled without lubrication. For stainless steel fasteners 6 mm and larger, the addition of Molykote 1000® lubricant must be specified and applied on the threads and under the nut head.

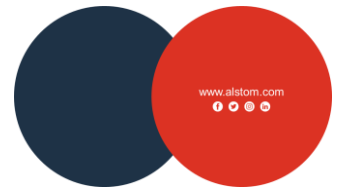

10.1.2 STANDARD TORQUE VALUES FOR IMPERIAL NUT - CP C20

BOBA reference : T2-150210P

Tightening torque values in foot pounds-force (ft-lbf), unless otherwise specified / Tightening performance class: **CP C20**
Screw diameter with torque values in *italic* are not standard and should be avoided

Nominal screw sizes are Imperial UNC, except #10-32 UNF	H and HSC screws **									
	Conical washers and flat washers									
Friction	Electroplated Zinc: $\mu_{\text{thread}} = 0.16$ to 0.26 $\mu_{\text{head}} = 0.12$ to 0.18			Head and threads: $\mu_{\text{ave}} = 0.275 \pm 0.075$ (dry) Head and threads: $\mu_{\text{ave}} = 0.16 \pm 0.04$ (Lubr)	Electroplated Zinc: $\mu_{\text{thread}} = 0.20$ to 0.30 $\mu_{\text{head}} = 0.12$ to 0.18	Head: $\mu_{\text{ave}} = 0.275 \pm 0.075$ Threads: $\mu_{\text{ave}} = 0.315 \pm 0.075$ (dry) Head: $\mu_{\text{ave}} = 0.16 \pm 0.04$ Threads: $\mu_{\text{ave}} = 0.2 \pm 0.04$ (lubr)				
	Class	SAE Grade 5	SAE Grade 8	No Grade	ASTM F593 CW ASTM F837 CW1	No Grade	SAE Grade 5	SAE Grade 8	No Grade	ASTM F593 CW ASTM F837 CW1
#4-40			6.0 in-lbf		5.50 in-lbf *	← Torque identical to H nut *				
#6-32			10.0 in-lbf		10.50 in-lbf *					
#8-32			20.0 in-lbf		19.50 in-lbf *					
#10-32			36.0 in-lbf		32.00 in-lbf *					
1/4"	90.0 in-lbf	10.5		60.0 in-lbf		93.0 in-lbf	11		62.0 in-lbf	
5/16"	15	22		10		15.5	22		10.5	
3/8"	26	37		17.5		28	39		18.5	
7/16"	42	59		28		44	62		30	
1/2"	64	90		43		67	95		45	
9/16"	91	129		60		96	135		65	
5/8"	127	180		84		133	188		90	
3/4"	226	320				238	335			
7/8"	365	515				385	540			
1"	545	770				575	810			
1-1/8"	680	1090				715	1150			
1-1/4"	955	1530				1010	1620			
1-3/8"	1250	2010				1320	2120			
1-1/2"	1660	2660				1750	2810			

(*) Stainless steel fasteners smaller than 1/4" are assembled without lubrication. For stainless steel fasteners 1/4" or larger, the addition of Molykote 1000[®] lubricant must be specified and applied on the threads and under the nut head.

(**) HSC style Carbon Steel Screws of diameter 1/4" and greater shall be made to ASTM A574, and are comparable to SAE Grade 8 Hardware

10.1.3 STANDARD TORQUE VALUES FOR IMPERIAL NUT - CP C20 – CARBON STEEL HARDWARE WITH GEOMET 321+VL





BOBA reference : T3-150210P				
Tightening torque values in foot pounds-force (ft-lbf), unless otherwise specified				
Tightening performance class: CP C20				
Screw diameter with torque values in <i>italics</i> are not standard and should be avoided				
Nominal screw sizes are Imperial UNC, except #10-32 UNF	H and HSC screws * 			
	Conical washers and flat washers 			
	 Hexagonal nut, Self-locking nut with plastic insert.		 with All-Metal Locking Nut	
	Geomet 321 + VL $\mu_{\text{thread}} = 0.09 \text{ to } 0.14$ $\mu_{\text{head}} = 0.09 \text{ to } 0.14$		Geomet 321 + VL $\mu_{\text{thread}} = 0.12 \text{ to } 0.17$ $\mu_{\text{head}} = 0.09 \text{ to } 0.14$	
Friction				
Class	SAE Grade 5	SAE Grade 8	SAE Grade 5	SAE Grade 8
5/16"	12	17	12.5	18
3/8"	20	29	22	31
7/16"	32	45	35	49
1/2"	49	69	53	75
9/16"	70	98	76	106
5/8"	97	137	105	148
3/4"	172	242	186	265
7/8"	275	385	300	420
1"	410	580	445	630
1-1/8"	510	820	555	895
1-1/4"	715	1150	780	1250
1-3/8"	940	1510	1020	1640
1-1/2"	1240	1990	1350	2170

(*) HSC style Carbon Steel Screws of diameter 1/4" and greater shall conform to ASTM A574, and are comparable to SAE Grade 8 Hardware





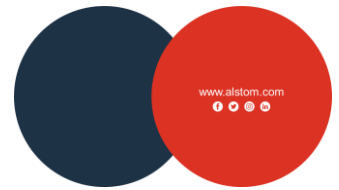

10.2. STANDARD TORQUE VALUES FOR NUT – CPC10

10.2.1 STANDARD TORQUE VALUES FOR NUT CPC10 – METRIC SCREWS

BOBA reference : T4-150210P						
Tightening torque values in Nm for Metric screws / Tightening performance class: CP C10 Stainless steel bolts are not included in this performance class Screw diameter with torque values in <i>italic</i> are not standard and should be avoided						
Fastener	H and HSC screws					
	CS washers and flat washers.					
	 Hexagonal nut, Self-locking nut with plastic insert.			 All metal lock nut FS & double slotted		
	Friction factor head and threads: $\mu_{ave} = 0.15 \pm 0.03$			Friction factor Head: $\mu_{ave} = 0.15 \pm 0.03$ Threads: $\mu_{ave} = 0.19 \pm 0.03$		
Class	8.8	10.9	12.9	8.8	10.9	12.9
8	22	32	38	24	36	40
10	44	64	76	46	70	80
12	75	110	130	80	120	140
<i>(14)</i>	<i>120</i>	<i>180</i>	<i>210</i>	<i>130</i>	<i>190</i>	<i>220</i>
16	190	270	320	200	290	350
<i>(18)</i>	<i>270</i>	<i>380</i>	<i>440</i>	<i>290</i>	<i>410</i>	<i>480</i>
20	380	540	620	400	580	680
<i>(22)</i>	<i>520</i>	<i>740</i>	<i>860</i>	<i>560</i>	<i>780</i>	<i>920</i>
24	650	920	1100	700	1000	1150
<i>(27)</i>	<i>960</i>	<i>1350</i>	<i>1600</i>	<i>1050</i>	<i>1450</i>	<i>1700</i>
30	1300	1850	2150	1400	2000	2350
36	2250	3200	3750	2450	3450	4050







10.2.2 STANDARD TORQUE VALUES FOR NUT CPC10 - IMPERIAL SCREWS – ZINC ELECTROPLATE

BOBA reference : T5-150210P				
Tightening torque values in foot pound-force (ft-lbf), unless otherwise specified / Tightening performance class: CP C10 Stainless steel bolts are not included in this performance class. Screw diameter with torque values in <i>italic</i> are not standard and should be avoided				
Nominal screw sizes are Imperial UNC, except #10-32 UNF	H and HSC screws* 			
	Conical washer and flat washers 			
	Hexagonal nut, Self-locking nut with plastic insert. 		All metal locknut 	
	Zinc Electroplate per ASTM B633/F1941 Friction factor $\mu_{\text{thread}} = 0.16 \text{ to } 0.26$ $\mu_{\text{head}} = 0.12 \text{ to } 0.18$		Zinc Electroplate per ASTM B633/F1941 Friction factor $\mu_{\text{thread}} = 0.20 \text{ to } 0.30$ $\mu_{\text{head}} = 0.12 \text{ to } 0.18$	
Class	SAE J429 Grade 5	SAE J429 Grade 8	SAE J429 Grade 5	SAE J429 Grade 8
1/4"	98.0 in-lbf	<i>11.5</i>	102.0 in-lbf	<i>12</i>
5/16"	16.5	<i>23</i>	17	<i>24</i>
3/8"	29	<i>41</i>	30	<i>43</i>
7/16"	<i>45</i>	<i>64</i>	<i>48</i>	<i>67</i>
1/2"	70	99	73	103
9/16"	<i>100</i>	<i>140</i>	<i>104</i>	<i>148</i>
5/8"	138	196	145	206
3/4"	246	350	260	365
7/8"	<i>395</i>	<i>560</i>	<i>420</i>	<i>590</i>
1"	595	840	625	885
1-1/8"	<i>740</i>	<i>1190</i>	<i>780</i>	<i>1250</i>
1-1/4"	<i>1040</i>	<i>1670</i>	<i>1100</i>	<i>1770</i>
1-3/8"	<i>1370</i>	<i>2190</i>	<i>1440</i>	<i>2310</i>
1-1/2"	<i>1810</i>	<i>2900</i>	<i>1910</i>	<i>3070</i>

(*) HSC style Carbon Steel Screws of diameter 1/4" and greater shall conform to ASTM A574, and are comparable to SAE Grade 8 Hardware

10.2.3 STANDARD TORQUE VALUES FOR NUT CPC10 - IMPERIAL SCREWS – GEOMET 321+VL

BOBA reference : T6-150210P				
Tightening torque values in foot pound-force (ft-lbf), unless otherwise specified. Tightening performance class: CP C10 ± 10% Screw diameter with torque values in <i>italic</i> are not standard and should be avoided				
Nominal screw sizes are Imperial UNC, except #10-32 UNF	H and HSC screws* 			
	Conical and flat washers 			
	Hexagonal nut, Self-locking nut with plastic insert. 		All metal locknut 	
Friction	GEOMET 321 + VL Friction factor head and threads: $\mu_{ave} = 0.09$ to 0.14		GEOMET 321 + VL Friction factor Head: $\mu_{ave} = 0.09$ to 0.14 Threads : $\mu_{ave} = 0.12$ to 0.17	
Class	SAE J429 Grade 5	SAE J429 Grade 8	SAE J429 Grade 5	SAE J429 Grade 8
5/16"	13	<i>18</i>	13.5	<i>19.5</i>
3/8"	22	<i>31</i>	24	<i>33.5</i>
7/16"	<i>35</i>	<i>49</i>	<i>38</i>	<i>53</i>
1/2"	54	76	58	82
9/16"	<i>76</i>	<i>107</i>	<i>82</i>	<i>116</i>
5/8"	105	149	114	162
3/4"	186	265	202	285
7/8"	<i>300</i>	<i>420</i>	<i>325</i>	<i>460</i>
1"	445	630	485	685
1-1/8"	<i>560</i>	<i>895</i>	<i>605</i>	<i>975</i>
1-1/4"	<i>780</i>	<i>1250</i>	<i>850</i>	<i>1370</i>
1-3/8"	<i>1030</i>	<i>1650</i>	<i>1120</i>	<i>1790</i>
1-1/2"	<i>1350</i>	<i>2170</i>	<i>1480</i>	<i>2370</i>

(*) HSC style Carbon Steel Screws of diameter 1/4" and greater shall conform to ASTM A574, and are comparable to SAE Grade 8 Hardware

10.3. TORQUE VALUES FOR SPECIAL ASSEMBLIES

10.3.1 METAL ASSEMBLIES - METRIC SCREWS

BOBA reference : T7-150210P

Tightening torques in Nm - CPC20				H nut (c)	Keensert®	Helicoil®	Rivet nut	Cage Nut
Screw (a)	Washer (b)	d	Material grade					
 CBHC or CBX HSB or HSBP		M3 M4 M5 M6	010.9 / A2 or A4-070 or 080	CPD				
		M8	A2 or A4-070 or 080	20	20*/20 **	20	CPD	
 FHC or FX HSF of HFSP (d)		M3 M4 M5	8.8 / A2 or A4-70 or 80	1 2.5 5	CPD			
		M6	A2 or A4-70 or 80	8,5 6***				
 H or HSC		M8	8.8 A2 or A4-70 A2 or A4-80	20 14*** 20***	20*/20 **	20 14 ** 20 **	CPD	
		M10	A2 or A4-70 A2 or A4-80	42 28*** 38***	42*/42**	42 28 ** 38 **		
		M12	8.8 A2 or A4-70 A2 or A4-80	70 50*** 65***	70*/70**	70 50 ** 65 **		

(a) Screw friction factor according to DTRF 150213

(b) These torques are valid in combination with flat and conical washer CS

(c) Tightening at nut side

(d) No washers

(**) Screw thread greased, screw head ungreased (under head)

(***) Screw thread greased, screw head greased (under head)

10.3.2 METAL ASSEMBLIES - IMPERIAL SCREWS

BOBA reference : T8-150210P								
Tightening torques in foot pound-force (ft-lbf) unless otherwise noted - All are performance class CP C20.				H nut (c)	Keensert®	Helicoil®	Rivet Nut	Cage Nut
Screw (a)	Washer (b)	d	Material grade					
 CBHC or CBX  HSB or HSBP  FHC or FX  HSF or HFSP (d)  H or HSC*	 	#4 #6 #8 #10	All Grades	CPD				
		1/4"	Carbon Steel Grade 5	90 in-lbf			CPD	
			Stainless steel: CW1	48.5 in-lbf***	64 in-lbf**			
		5/16"	Carbon Steel Grade 5	15 / 12*				
			Stainless steel: CW1	99.0 in-lbf***	11**			
		3/8"	Carbon Steel Grade 5	26 / 20*				
Stainless steel: CW1	15***		20**					
 	 	#4 #6 #8 #10	All Grades	CPD				
		1/4"	Carbon Steel Grade 5	90 in-lbf				
			Stainless steel: ASTM F593 CW1	60 in-lbf***	78 in-lbf**			
		5/16"	Carbon Steel Grade 5	15 / 12*				
			Stainless steel: ASTM F593 CW1	10***	13**			
		3/8"	Carbon Steel Grade 5	26 / 20*				
Stainless steel: ASTM F593 CW1	17.5***		23**					

(*) HSC style Carbon Steel Screws of diameter 1/4" and greater shall be conform to ASTM A574, and are comparable to SAE Grade 8 Hardware

(a) Carbon steel torques listed for **zinc electroplate coating standard**.

(b) These torques are valid in combination with flat and conical washers CS

(c) Tightening at nut side

(d) No washers

(*) Torque listed for **Geomet 321 + VL coating**

(**) Screw thread greased, screw head ungreased (under head)

(***) Screw thread greased, screw head greased (under head)



10.3.3 TORQUE VALUE FOR FIBER REINFORCED PLASTIC PARTS ASSEMBLY (METRIC AND IMPERIAL)

	Assemblies without metallic insert	Assemblies with metallic insert
Interfaces	Composite	Metallic
Torque values	Defined by calculation and systematically confirmed by qualification & validation tests	Standard torque tightening value
Performance class	CPC20	

10.3.4 TORQUE VALUE FOR PLASTIC, ELASTOMER AND RUBBER ASSEMBLIES (METRIC AND IMPERIAL)

	Assemblies without metallic insert	Assemblies with metallic insert
Interfaces	Plastic, Elastomer, Rubber, Paper join	Metallic
Torque values	Defined by calculation and systematically confirmed by qualification & validation tests	Standard torque tightening value
Performance class	CPC20 or CPC10	

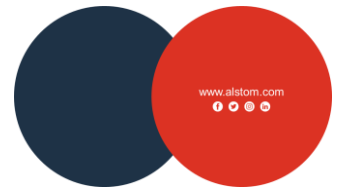

11. DEPARTMENT RESPONSIBILITY AND TIGHTENING METHOD

The engineering department is responsible for determining the intensity of the efforts exerted on the assembly, for dimensioning the assembly and for defining fastening elements designation, as well as the minimum, nominal and maximum pre-stresses.

In cooperation with the methods office, depending on tightening tools available in production and maintenance, their accessibility, their required precision, a tightening method used to reach the nominal tension is selected (tightening method - torque, tensioning, fusible bolt, tightening path ...). The engineering office will validate the selected tightening method and will then indicate the selected performance class.

The methods department will then determine the tightening tool adapted to the performance class that will be used for the assembly and bolting sequences.

12. MOUNTING PRESCRIPTIONS

The mountings prescriptions, inspections to be made before and after tightening, control method, retightening, re-using of components are indicated into ALSTOM Standard DTRF 150214.