

# HITACHI

S&T	SPECIFICA DI VERNICIATURA <i>PAINTING SPECIFICATION</i>
-----	--

## VERNICIATURA VEICOLI HS2

### *PAINTING HS2 VEHICLES*

Questo documento è proprietà di Hitachi Rail STS S.p.A. e non può essere riprodotto o il suo contenuto comunicato a terzi senza autorizzazione scritta di Hitachi Rail STS S.p.A.

#### Livello di riservatezza

Copyright reserved.

È vietato consegnare a terzi o riprodurre questo documento, utilizzarne il contenuto o renderlo comunque noto a terzi senza esplicita autorizzazione. Ogni infrazione comporta il risarcimento dei danni subiti. Sono riservati tutti i diritti derivanti dalla concessione di brevetti per invenzioni industriali di utilità o di brevetti per modelli ornamentali.

The reproduction, distribution and utilization of this document as well as the communication of its contents to other without express authorization is prohibited. Offenders will be held liable for the payment of damages. All rights reserved in the event of the grant of a patent, utility model or design.

Modello Specifiche PRG (IT-EN)_HITACHI.Doc	Created	2023-09-29	AGotti	PAINTING HS2 VEHICLES		
EC090015251_02_20 23_09_29	Checked	2023-09-29	PMontedo			
	Approved	2023-09-29	MRomani			
<b>HITACHI</b>	Date	Name				
	it/en	SI				
	EC090015251			02	I/II	



**Sezione 1 – Lingua italiana (it)**

N.A.

---

## Section 2 – English language (en)

### Index:

1.	Purpose .....	3
2.	Field of Application. ....	3
3.	Terms and Definitions .....	3
4.	REFERENCE DOCUMENTS.....	6
4.1	Laws and regulations.....	6
4.2	HR Documents .....	6
4.3	AT Documents.....	6
4.4	Standards.....	7
5.	ENVIRONMENTAL AND SERVICE CONDITIONS.....	9
5.1	Environmental conditions .....	9
5.2	Corrosivity Categories Allocation.....	11
6.	HEALTH, SAFETY AND DESIGN FOR ENVIRONMENT .....	12
6.1	Safety and Health.....	12
6.2	Design for Environment.....	12
7.	COLORS AND FINISHES ARRANGEMENT.....	13
8.	SURFACES TREATMENTS.....	13
8.1	General .....	13
8.2	Surfaces Preparation and Treatments .....	14
8.2.1	Surface Preparation Grade .....	14
8.2.2	Steel Surfaces Pretreatment .....	16
8.2.3	Pretreatment of aluminium surfaces .....	17
8.2.4	Pretreatment of stainless steel surfaces to be coated.....	17
8.2.5	Pretreatment of plastics.....	18
9.	Painting System .....	19
9.1	Preliminary Recommendations.....	19
9.1.1	Surfaces Protection .....	19
9.1.2	Inner surfaces of hollow spaces.....	19
9.1.3	How to fill gaps on overlaps .....	20
9.1.4	Film thickness.....	21
9.1.5	Coating in connections areas .....	21
9.1.6	Coating of rail on carbody structure.....	22
9.1.7	Strip Coating.....	23
9.1.8	Accessibility.....	23
9.1.9	Surface Flatness .....	24
9.1.10	Climatic conditions .....	24
9.1.11	Edges resulting from masking.....	24

9.1.12	Edges resulting from masking .....	24
9.1.13	Repairing Procedure.....	24
9.1.14	Overspray in not visble area .....	24
9.2	Painting Systems .....	25
9.2.1	General.....	25
9.2.1.1	Painting Repairing .....	25
9.2.2	Fire Behaviour .....	25
9.2.3	Painting System Structure .....	26
9.2.4	Painting System Allocation.....	27
10.	QUALIFICATION .....	28
10.1	Painting System Qualification.....	28
10.1.1	Painting System Zone D – Test List .....	29
10.1.1.1	Painting System with putty.....	32
10.1.2	Painting System Zone A1,K1 – Test List.....	33
10.1.3	Painting System Zone A2,K2 – Test List.....	33
10.1.4	Painting System Zone A3,K3 – Test List.....	33
10.1.5	Anticorrosion Primer Requirements.....	34
10.1.6	Powder Painting System .....	35
10.2	Labels and Signage.....	37
10.3	Painting Process Qualification – Wet Paint .....	38
10.4	Painting Process Qualification – Powder Paint.....	40
11.	DOCUMENTATION.....	43
11.1	Documents request to the Paint manufacturer.....	43
12.	Requirements for SEC suppliers .....	44

---

## 1. Purpose

This document defines structure and requirements of the painting systems to be applied for *external painting* of HS2 train vehicles. This specification covers also the others parts located into the internal vehicle, purchased by HR (Hitachi Rail).

The paint products must be selected on the basis of this document.

All others recommendations regarding the corrosion protection to be considered, are reported in doc. AT (Alstom) 100569340 and Hitachi Rail DB040015421

This document provides the requirements for *painting materials* to be supplied to HR (*Hitachi Rail*) and those to be applied to the *System and/or Equipment and/or Components, purchased by HR*.

*Unless otherwise specified, all painted parts not covered by this document shall meet the requirements in the Alstom painting specification 100566298.*

## 2. Field of Application.

- a) The painting systems defined in this section and their requirements are applicable to all parts designed by HR;
- b) *All purchased external additions to the vehicle, which have to guarantee the homogeneity of the external livery (Zones D,A1,K1,A2,K2), shall adopt the same painting systems and products used by HR for its parts; any deviation from this requirement shall be agreed between HR and the SEC suppliers (suppliers of System and/or Equipment and/or Components);*
- c) Same painting system and products, used by HR for its parts, are recommended for all equipment, components and spare parts not in visual contact (**For Zone A3,K3**) . Deviations to this recommendation are accepted only if the requirements, defined in this specification, are met (see section 12).

## 3. Terms and Definitions

Unless otherwise defined here below, terms and definitions of the standard EN ISO 4618:2014 are applicable.

Complex area of application: A complex zone of application is a zone presenting plane direction changes and of which at least one dimension is less than 100 mm.

DFT: Dry film thickness

Exposed (parts/areas): all areas, equipment and components exposed to corrosivity category C4 (see table at the §5.2) and to the service conditions.

GRP: (Glass Reinforced Plastic) Fiberglass composite

---

Inspection Zone (as per VDB Guideline):

Zone	Location	Rail Vehicle Area / Sector
D	External and Internal vehicle, exposed and in visual contact	Visible decorative areas, exterior and interior
A1, K1	External vehicle, exposed and not in visual contact (exposure with solar radiation)	Exterior technical areas (i.e: roof zone, bulkhead); K: Equipment and parts
A2, K2	External and Internal vehicle, exposed and not in visual contact (exposure without solar radiation)	Exterior in internal technical areas (i.e: undercarriage); K: Equipment and parts
A3, K3	External vehicle, not exposed and not in visual contact	Exterior technical areas (i.e: closed area within the skirts); K: Equipment and parts
I	Interior Technical areas, not exposed and not in visual contact	Painted area inside the carbody

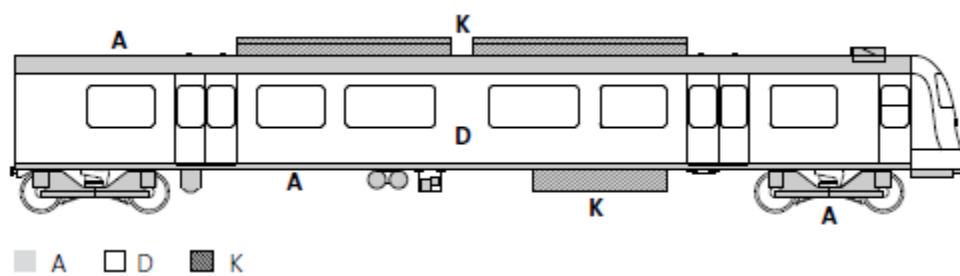

Master of Reference: element of limited dimensions (ISO A4) coated by the paint manufacturer, approved by the customer during the design or maintenance phase; if it is not possible to fix requirements by drawings and/or specifications or others methods, the sample of reference is integrating part of the technical specification of requirements and as consequence it must be identified by a proper tag showing at least the following information:

The master shall be identified by a *proper tag* showing at least the following information:

- Project
- Supplier's business name
- HR Purchase Order No.
- Part to which the cycle applies
- Painting System ID
- Painting System Structure
- Finishing - Colour Code (i.e: RAL, NCS etc);
- Finishing - Colour Reference (i.e.: White, Black, etc)
- Finishing - Light Reflectance Value (LRV);
- Finishing – Color Coordinates (L\*,a\*,b\*,C,h°);
- Finishing texture (Smooth, matt, etc)
- Gloss (at 60° and 20° if applicable)
- Dry film Thickness
- Adhesion degree (ISO 2409)

The master shall be made by giving evidence of the applied process, so it shall be possible to check the single layers of paint and verify the preparation of the substrate (e.g. roughness); *an example of a proper tag is here below reported; others tags configuration can be accepted, if they reports the information here requested.*

Project: Supplier:	HR Purchase order: Part to which the cycle applies: Painting System structure code (see sect. 9.2.3): Painting system structure (description):
207 mm	Painting product code and trademark of top coat: Finishing characteristics (reports the information request above): Gloss; Dry film thickness: Adhesion degree (ISO 2409)
30 mm	Painting product code and trademark of filler; Colour code Dry film thickness; adhesion degree
30 mm	Painting product code and trademark of filler; Colour code Dry film thickness; adhesion degree
30 mm	Surface pretreatment to be adopted Roughness (measure Ra and R <sub>Pc</sub> (0.5))

**Master Sample:** workmanship sample of limited dimensions (ISO A4), comply with the master of reference ( $\Delta E_{00} \leq 1$  ISO 11664-6; Gloss:  $\pm 5$  GU) made by applicable working instructions used to check the painting process and approved by the customer and/or Hitachi Rail. The master sample shall be identified by a proper tag as per master of reference.

**Painting system:** see coating system definition into the standard EN ISO 4618:2014

**Paint Manufacturer:** supplier of products used in the painting process;

**Qualification:** process of verification of the specified requirements which is developed through tests;

**SEC Supplier:** supplier of systems, equipment and components, which is responsible of the products design delivered to HR;

**Visual Contact:** visible to the crew and passengers

**Work Instructions:** document which present a sequence of steps to make the painting process during the serial production (cleaning, surface treatments, paints, mixing.pot life, drying time, etc).

**Painting System Qualification:** Verification of the specified requirements, allocated to the painting systems, by testing to be performed by the paint manufacturer or by HR or SEC supplier or a third part agreed between the supplier and HR;

**Painting Process Qualification:** Verification of the specified requirements by testing to qualify the work instruction used for manufacturing of the serial production;



## 4. REFERENCE DOCUMENTS

### 4.1 Laws and regulations

- a) All requirements imposed by Laws and/or Regulations of the current legislation shall apply; in particular, those related to the chemical products. The current legislation is related to the ones in force in the country where the paints products will be used;
- b) The paints products suppliers have the responsibility to monitor the status of the existing legislation, in order to verify the possible evolution and its impact on own product. In case of evolution, the supplier must notify to HR, the analysis of the consequences on the supply;

### 4.2 HR Documents

ID	Title	Code
01	Painting Cycle Qualification	AQU/IO/050 Rev.04
02	Corrosion Protection Concept	AT doc. 100569340 HR doc. DB040015421
03	Painting Diagram	(*)
04	Schedule of Finishes - External	EC100016475 (**)
05	Determination of graffiti resistance	EC07P023203B Rev.01

(\*) Painting diagrams (see chp. 7) are the documents to be considered always together this painting specification and Schedule of Finishes – External.

(\*\*) to be considered always the last version in force

### 4.3 AT Documents

ID	Title	Code
01	Painting Specification	100566298

## 4.4 Standards

ID	Title	Code
01	Railway rolling stock — Protection and ornamentation by painting of car body and components parts — Part 1: General provisions	NF F 19-141-1 (2018)
02	Railway rolling stock — Protection and ornamentation by painting of car body and components parts — Part 2: description and use of paint systems (except wagons)	NF F 19-141-2 (2018)
03	paints and varnishes — corrosion protection of steel structures by protective paint systems — part 2: classification of environments	ISO 12944-2:2017
04	Paints and varnishes - Corrosion protection of steel structures by protective paint systems - Part 3: Design considerations	ISO 12944-3: 2017
05	Paints and varnishes — Corrosion protection of steel structures by protective paint systems —Part 4: Types of surface and surface preparation	ISO 12944-4: 2017
06	Paints and varnishes — Terms and definitions	ISO 4618: 2014
07	Preparation of steel substrates before application of paints and related products - Visual assessment of surface cleanliness - Part 3: Preparation grades of welds, edges and other areas with surface imperfections	ISO 8501-3:2007
08	Preparation of steel substrates before application of paints and related products – Visual assessment of surface cleanliness – Part 1: Rust grades and preparation grades of uncoated steel substrates and of steel substrates after overall removal of previous coatings	ISO 8501-1:2007
09	Preparation of steel substrates before application of paints and related products - Surface roughness characteristics of blast cleaned steel substrates - Part 1: Specifications and definitions for ISO surface profile comparators for the assessment of abrasive blast-cleaned surfaces	ISO 8503-1:2007
10	Preparation of steel substrates before application of paints and related products — Surface preparation methods — Part 3: Hand- and power-tool cleaning	ISO 8504-3:2018
11	Preparation of steel substrates before application of paints and related products — Tests for the assessment of surface cleanliness — Part 3: Assessment of dust on steel surfaces prepared for painting (pressure-sensitive tape method)	ISO 8502-4:2017
12	Preparation of steel substrates before application of paints and related products — Tests for the assessment of surface cleanliness — Part 6: Extraction of water soluble contaminants for analysis (Bresle method)	ISO 8502-6:2020
13	Preparation of steel substrates before application of paints and related products — Tests for the assessment of surface cleanliness — Part 4: Guidance on the estimation of the probability of condensation prior to paint application	ISO 8502-4:2017
14	Criteria for evaluating the coated surfaces of rail vehicles	VDB Guideline
15	Technical product documentation - Edges of undefined shape - Indication and dimensioning	EN ISO 13715:2019
16	Colorimetry - Part 6: CIEDE2000 Colour-difference formula (ISO/CIE 11664-6:2014)	EN ISO/CIE 11664-6:2016
17	Paints and varnishes -- Determination of the gloss value at 20 degrees, 60 degrees and 85 degrees	ISO 2813:2014
18	Paints and varnishes -- Determination of the film thickness	ISO 2808:2019
19	Non-conductive coatings on non-magnetic electrically conductive base metals — measurement of coating thickness — amplitude-sensitive eddy-current method	ISO 2360:2017
20	Paints and varnishes -- Cross-cut test	ISO 2409:2020
21	Paints and varnishes -- Pull-off test to check adhesion	ISO 4624:2016
22	Paints and varnishes -- Pendulum damping test	ISO 1522:2006
23	Paints and varnishes -- Buchholz indentation test	ISO 2815:2003

24	Paints and varnishes - Bend test (cylindrical mandrel)	ISO 1519:2011
25	Paints and varnishes -- Cupping test	ISO 1520:2006
26	Paints and varnishes – Rapid deformation tests (impact resistance) -- Part 1: Falling weight impact test, large-area indenter	ISO 6272-1:2011
27	Paints and varnishes -- Determination of the scratch resistance -- Part 1: Constant-loading method	ISO 1518-1:2019
28	Paints and varnishes -- Determination of the resistance to liquids -- Part 1: Immersion in liquids other than water	ISO 2812-1:2017
29	Paints and varnishes -- Determination of the resistance to liquids -- Part 2: Water immersion method	ISO 2812-2: 2018
30	Paints and varnishes -- Determination of the resistance to liquids -- Part 3: Method using an absorbent medium	ISO 2812-3:2019
31	Paints and varnishes — Determination of the scratch resistance of a coating system using a laboratory-scale carwash	ISO 20566:2020
32	Adhesives — Guide to the selection of standard laboratory ageing conditions for testing bonded joints	ISO 9142:2003
33	Paints and varnishes -- Determination of the resistance to humidity - Condensation (in-cabinet exposure with heated water reservoir)	ISO 6270-2:2017
34	Corrosion tests in artificial atmospheres - Salt spray tests	ISO 9227:2017
35	Paints and varnishes – Determination of stone-chip resistance of coatings – Part 1: Multi-impact testing	ISO 20567-1:2017
36	Paints and varnishes – Determination of resistance to abrasion – Part 2: Method with abrasive rubber wheels and rotating test specimen	ISO 7784-2: 2016
37	Paints and varnishes -- Methods of exposure to laboratory light sources -- Part 2: Xenon-arc lamps	ISO 16474-2:2013
38	Paints and varnishes - Determination of resistance to cyclic corrosion conditions - Part 1: Wet (salt fog)/dry/ humid	ISO 11997-1:2017

## 5. ENVIRONMENTAL AND SERVICE CONDITIONS

### 5.1 Environmental conditions

Unless otherwise specified, the painting systems shall guarantee the corrosion protection in the environmental condition defined by the here below listed indications:

[JV-HS2-WPB02-CCO-00002]

The unit shall be capable of normal operation in the tunnel environmental conditions.

- Normal operation of the vehicle in tunnel temperatures of 43°C and humidity ratio of 0.012 kgwater/kgdry\_air for undefined period.
- Normal operation of the vehicle in tunnel temperatures of 50°C and humidity ratio of 0.012 kgwater/kgdry\_air for up to five minutes.

[JV-HS2-WPB02-CCO-00003]

The unit shall meet the requirements of LOC&PAS NTSN Section 4.2.6.1.1 and EN 50125, All equipment shall be able to operate within temperature range T1 as per EN 50125-1:1999:

- ambient external air temperatures of -25°C to +40°C
- inside vehicle compartment (Saloon or Cab) temperatures of -25°C to +50°C
- internal cubicle temperatures of -25°C to +70°C

This nominal temperature range should be considered for all sub components of unit design.

The following external humidity levels shall be assumed, according to EN 50125:

- Yearly average: below 75%
- Occasionally: between 95% and 100%

[JV-HS2-WPB02-CCO-00004]

Tunnel Environment – Summer

The Unit shall be capable of Normal Operation (full traction) in the tunnels that will transition from 25°C at the tunnel entry portal to 35°C within the tunnel. Humidity ratio of 0.012 kgwater/kgdry\_air with Relative humidity between 30% and 50%.

Tunnel Environment - Winter

The Unit shall be capable of Normal Operation (full traction) in the tunnels that will transition from -6°C at the tunnel entry portal to 30°C within the tunnel. Humidity ratio of 0.012 kgwater/kgdry\_air. Tunnel Relative humidity will vary between 90% at the cool end of the tunnel and 20% to 30% at the warmest part of the tunnel.

Tunnel Congestion Conditions – Average

The Unit shall be capable of Normal Operation (full traction) when the tunnel temperature is an average of 43°C, with variations around the vehicle.

Tunnel Congestion Conditions – Maximum

The Unit shall be capable of Normal Operation (full traction) when the tunnel temperature is an average of 50°C, with variations around the Vehicle, for up to five minutes.

[JV-HS2-WPB02-CCO-00017]

All external components of the Unit shall withstand, without damage, normal operation in conditions of hail, with a maximum hail diameter of 15mm.

[JV-HS2-WPB02-CCO-00047]

The unit shall be design to withstand the solar radiation of maximum exposure of 1120W/m<sup>2</sup> for up to 8 hours, in accordance with EN 50125-1 paragraph 4.9

---

[JV-HS2-WP-REQ-00184]

The exterior paint system shall be unaffected by frequent wetting with screen washes, by the seasonal application of de-icing fluids containing Alcohol and Glycol;

[JV-HS2-WP-REQ-00194]

The exterior vinyl film shall be unaffected by frequent wetting with screen washes, by the seasonal application of de-icing fluids and the chemical constituents of Alcohol and Glycol.

[JV-HS2-WP-REQ-00044]

The exterior paint system and applied films shall be resistant to the effects of routine cleaning and the removal of graffiti;

[JV-HS2-WP-REQ-00134]

All the materials and components shall not be degraded by scratching and abrasion in accordance with BS EN ISO 7784-1 and BS EN ISO 1518.

[TTS-886]

The exterior and interior finishes, including any films and decals in the scope of this Agreement, shall withstand damage and deterioration from a reasonable range of cleaning products, such that there is no unacceptable loss or change in texture, gloss or colour of the finishes.

[TTS-1216]

The external paint system shall maintain the Minimum Aesthetic Standard for at least 15 years life, assuming that the nose section is repaired every 6 months and other parts of the Unit are repaired every 3 years.

[TTS-1217]

The external paint system shall be compatible with installation and removal of decals, which may cover the whole exterior of the Unit.

[TTS-2864]

The finish of the Carbody, Exterior Doors and other exterior surfaces visible to Passengers shall be resistant to chips, scratches and marks from ballast strikes and other items the Unit is likely to contact.

[TTS-745]

All labelling and signage shall be resistant to forced removal and deliberate defacing activities

[TTS-746]

It shall be possible to remove labels without damage to panels / substrate.

[JV-HS2-WPB02-CCO-00048]

The design of the Unit shall be resistant to pollution in accordance with EN 50125-1 paragraph 4.11.  
(cleaning products – fire extinguishing products)

(As adding: Painting system shall be resistant to the effects of Toilet and Sanitary systems' discharge fluids)

[TTS-1989]

The exterior of the Vehicle, including Running Gear, shall be compatible with cleaning by high pressure hose.

---

## 5.2 Corrosivity Categories Allocation

Painting systems shall be defined also considering the corrosivity categories allocated, as here below:

Corrosivity category	Vehicle area
Low / C2	<u>Interior:</u> <ul style="list-style-type: none"> <li>- ceiling &amp; side wall covering</li> <li>- other internal components (if not mentioned below)</li> <li>- brackets mounted to interior carbody (except areas where stagnant water is present)</li> </ul> <u>Exterior:</u> <ul style="list-style-type: none"> <li>- inside underframe housing (if dryness is ensured, air grids which allow water ingress results in classification change)</li> </ul>
Medium / C3	<u>Interior:</u> <ul style="list-style-type: none"> <li>- toilets (except floor)</li> <li>- bistro area</li> <li>- side wall below lower window edge</li> <li>- door openings &amp; door inside</li> <li>- brackets mounted to carbody where stagnant water can be present (e.g. floor)</li> </ul> <u>Exterior:</u> <ul style="list-style-type: none"> <li>- exterior underframe (not exposed parts)</li> </ul>
High / C4	<u>Interior:</u> <ul style="list-style-type: none"> <li>- inner flooring incl. toilets floor area</li> </ul> <u>Exterior:</u> <ul style="list-style-type: none"> <li>- cab, crash absorber, door</li> <li>- roof and sidewall</li> <li>- underframe (exposed parts)</li> <li>- underframe housing interior (if water ingress is possible (air grids))</li> <li>- not enclosed access areas (e.g. bogies)</li> </ul>
<p>The actual mounting situation must be <b>thoroughly considered</b>. In example, a bracket attached to the interior floor can be classified as high if a corrosive media (cleaning agent or stagnant water) might be present. The component mounted to the same bracket can be considered as low if sufficient distance (&gt;20 mm) to the corrosive media can be granted.</p>	

Corrosivity categories above are based on EN ISO 12944-2.

## 6. HEALTH, SAFETY AND DESIGN FOR ENVIRONMENT

### 6.1 Safety and Health

[JV-HS2-WPB18-DFE-00021]

All suppliers are to comply with the EU regulation 1907/2006/EC on the Registration, Evaluation, Authorization and Restriction of Chemicals (REACH), including:

[JV-HS2-WPB18-DFE-00022]

- Substances of Very High Concern (SVHC) according to the REACH Candidate List (Regulation (EC) No 1907/2006, Article 33, Annex XIV), present in concentrations above 0.1 % weight by weight, shall not be used in the delivered article, unless written permission is obtained from HBH-S. If it is necessary to use SVHC the Supplier shall request permission using the derogation template (Z1 Template)

[JV-HS2-WPB18-DFE-00023]

- SVHC, given written permission for use by HBH-S, shall be specified with sufficient information to allow safe use of the article. The Supplier shall deliver, where applicable, information to allow safe use in English language, using the derogation template (Z1 Template).

[JV-HS2-WPB18-DFE-00024]

- The information provided by the supplier according to this chapter shall be continuously updated following the publication of changes in the REACH Candidate list.

[JV-HS2-WPB18-DFE-00026]

- Suppliers shall declare compliance to European Regulations with particular reference to REACH filling the Declaration of Conformity (Z2 Template).

[JV-HS2-WPB18-DFE-00027]

Supplier shall provide, *Technical and Safety Data Sheets* (SDS) for substances and preparations supplied, contained in supplied articles, or specified to be used. The Safety Data Sheets shall be delivered in English according to REACH (1907/2006/EC). (Z3)

### 6.2 Design for Environment

[JV-HS2-WPB18-DFE-00042]

Supplier, shall compile the Material Declaration Template (Z4 Template) and shall declare the distance and mode of transport and GROSS weight from the Supplier to HAH-S for the supplied items.

---

## 7. COLORS AND FINISHES ARRANGEMENT

- a) The livery of the exterior vehicle, together the finishing of equipment and components located outside the vehicle are defined in the doc. EC100016475 (Scheme o finishing, SoF);
- b) Painting diagrams for Carbody Structure based on SoF, shall contain:
  - 1. allocation of the painting system as per par. 7.2.4
  - 2. area, in m<sup>2</sup> covered by each painting system;
  - 3. Color, Gloss and type of finishing required for each painting system (if applicable);
  - 4. Allocation of the painting systems to each painted surfaces.
  - 5. Positioning dimensions of the separation lines between different colors (if applicable) and/or between each painting system;
  - 6. Definition of the Inspection Zone Allocation
  - 7. Reference code of the Painting Material Specification EC090021636 (Wet Paint)
- c) All drawings or others documents issued by HRSTS, which require the painting (frames, skirts, brackets, Boxes etc), shall report the following information:
  - 1. allocation of the painting system as per par. 7.2.4, table 3
  - 2. inspection Zone as per par. 7.2.4, table 1
  - 3. Color, Gloss and type of finishing required for each painting system (if applicable);
  - 4. Reference code of the Painting Material Specification EC090021636 (Wet Paint) and EC090021699 (Powder Paint)
- d) SEC Suppliers shall provide their painting diagram with colors and finishes arrangement together the allocation of the selected painting system (Documents to be attached to the corrosion control plan; CDRL List AA-6)

## 8. SURFACES TREATMENTS

### 8.1 General

- a) Painting system performances request in this specification are based on Standard practices for surface preparation and pre-treatment described in the following paragraphs.
  - b) All components and assemblies to be coated must be prepared / pre-treated immediately prior to coating; any deviation to this condition shall be agreed from HR corrosion protection engineering
  - c) The coating application must be completed without delay after preparation / pre-treatment.
  - d) Prior to applying the corrosion protection primer, discoloration / tempering colors (especially in stainless steel), slag residue and weld splashes must be carefully removed from weld joints
  - e) If necessary, paints manufacturer may propose deviations to the following practices in order to be approved by HR.
  - f) As regard powder painting, If pre-anodization is used as pre-treatment the thickness must be between 4 and 8 µm.
  - g) If necessary, oil and grease removal can be checked, by Wood lamp or wettability test.
-



## 8.2 Surfaces Preparation and Treatments

### 8.2.1 Surface Preparation Grade

- a) Before applying anticorrosive prime coat, make sure to carefully clean all welds from residual cinder and welding spatter. A homogeneous coating shall also be ensured on weld pores and end craters. Gaps shall be filled by means of a sealing compound. Pockets and other small hollow spaces which cannot be sealed in this way, shall be caulk-welded. Preparation grade of external **weldings** exposed to a corrosivity category C4 shall be P3 according to ISO 8501-3 (see EN ISO 12944-3:2017, par.5.5); for corrosivity category C3, P2 is acceptable. Any deviation to this requirement shall be agreed from HR corrosion protection engineering.

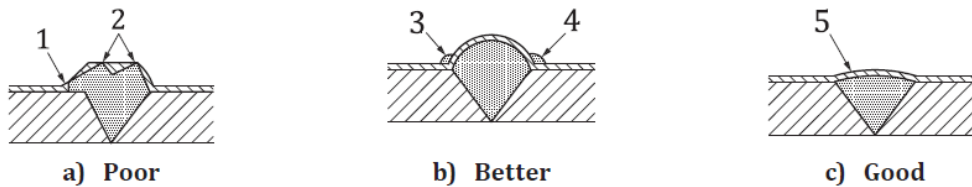

**Key**

- 1 protective paint system
- 2 irregularities
- 3 weld insufficiently flat
- 4 accumulated dirt
- 5 smooth weld surface

**Figure D.6 — Avoidance of welding surface imperfections**

Figure taken from standard EN ISO 12944-3:2017, annex D.

Welded seams in the areas with aesthetic requirements have to be made even and grinded

- b) **Surfaces imperfections:** Preparation grade in the areas exposed to a corrosivity category C4 shall be P3 according to ISO 8501-3 (see EN ISO 12944-3:2017, par.5.5); for corrosivity category C3, P2 is acceptable. Any deviation to this requirement shall be agreed from HR corrosion protection engineering
- c) **Edges:** (indications here below taken from JV doc. 100569340-DB040015421)

Difference between deburring/fettling, chamfering (breaking up the edge), bevel & radius

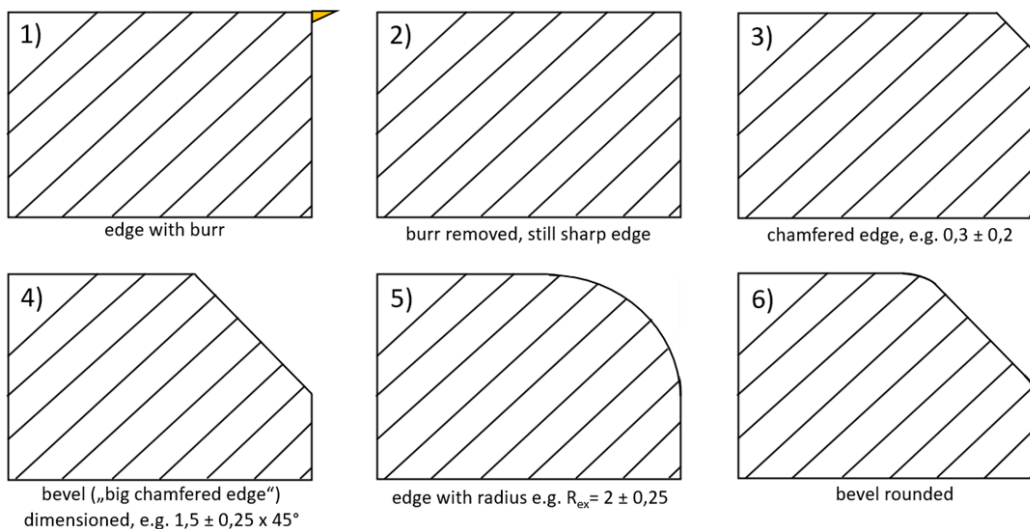

The edge processing in accordance with ISO 13715 must be given on drawings. From the following images, the minimum chamfer values are given

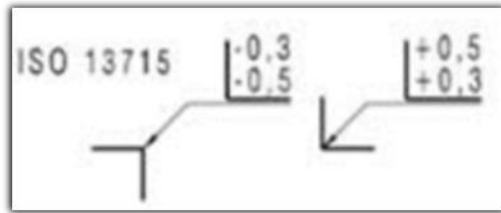

minimum required chamfer values for edges which will **get painted** (permitted to be greater)

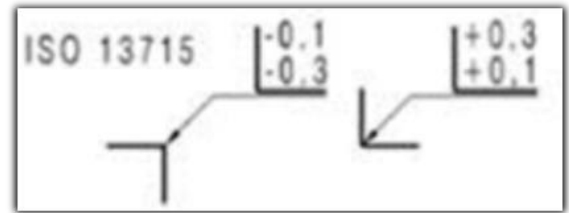

minimum required chamfer values for edges **without painting**

Edges must be processed. Burrs must be removed. The minimum required edge treating for painted and non-painted parts is chamfering

**Edges of all external parts exposed (see definition at the chp. 3) to a corrosivity category C4 must have a radius of  $r \geq 2$  mm (the higher the better) to prevent the coating from thinning on these edges.**

At locations where the requirements to minimum radius cannot be met for design reasons or due to the material thickness the design must be adjusted to meet the requirements.

***Not exposed parts may have radii smaller than 2 mm and chamfered edges but in this case they must always be pre-coated (see strip coating at the § 9.1.6). The appropriate drying period between the pre-coating and finishing must be adhered to.***

- d) Before blasting, the surfaces shall be free from grease and corrosion products.
- e) Parts not suited for blasting shall be suitably pre-treated with chemical agents (small parts may also be treated mechanically). The shape of the components shall be taken into account for these processes. Residues, e.g. in gaps and overlaps, are not acceptable. The process shall be coordinated with the paint manufacturer, and the effectiveness shall be monitored.
- f) Pretreatment depends on the material and the surface condition.
- g) All residuals of the preparation process must be removed**
- h) The residuals in the difficult accessible areas during the preparation process shall be removed by means of compressed air or by vacuum cleaner. If used Compressed air , it shall be dry and free of oil.**

**8.2.2 Steel Surfaces Pretreatment**

- a) Oil, grease, salts, dirt and similar contaminants shall be removed prior further surface preparation, using an appropriate method (see EN ISO 12944-4:2017 – annex C)
- b) The pre-treatment of steel surfaces is subject to ISO 8501-1, preparation grade Sa 2 ½ (Blast Cleaning Grade) and ISO 8503-1, roughness Ra, min. 3,2 µm, max. 12,5 µm [ 12.5 µm ≤ Rz ≤ 42 µm]
- c) Abrasive blast cleaning method shall be comply with ISO 8504-2;
- d) Hand and power tool cleaning grades St 3 and ISO 8503-1, roughness Ra, min. 3,2 µm, max. 12,5 µm [ 12.5 µm ≤ Rz ≤ 42 µm] (applicable where blast cleaning cannot be performed)
- e) Hand and/or power tool cleaning shall comply with ISO 8504-3.
- f) the blast cleaning shall be carried out immediately prior the painting operation.
- g) After blasting parts must be cleaned from blasting residues. This includes even hollow spaces which will not be painted.
- h) Painting is allowed if steel surface temperature is 3°C above the dew point temperature (see ISO 8502-4)
- i) Painting is allowed if flash rust is not present.
- j) Painting is allowed if confirmed an absence of soluble contaminants through the method according to ISO 8502-6:
  - Salts <3 µg /cm<sup>2</sup>;
- k) Painting is allowed if confirmed Absence of dust through the method according to ISO 8502-3 part 3 - Class 0-1 for all types of support.

As alternative if chemical treatment will be used, the standard EN ISO 12944-4:2017, § 6.8 shall be applied.

---

### 8.2.3 Pretreatment of aluminium surfaces

Oil, grease, salts, dirt layers of anodic oxidation and others contaminants shall be removed prior further surface preparation

- A. Mechanical pre-treatment), grit blasting cleaning shall be performed in order to have a roughness mean value Ra: 5 µm [Rz: 19 µm]. Where not possible to use grit blasting, hand and/or power suitable tool cleaning can be used. Blast cleaning abrasive mineral materials with a consistence of iron ≤ 1% are allowed. Belong to the mineral blasting materials are: - Corundum, Aluminium silicate glass melt, melt chamber slag; Electrocorund Glass globules, etc. Stainless steel grit abrasive type Stelux CG is allowed.

After blasting parts must be cleaned from blasting residues. This includes even hollow spaces which will not be painted.

Chemical pre-treatment: For single parts, not fixed assembly parts and small components a chemical pre-treatment with pickling solution (for instance phosphor acid solution) under consideration of the following working steps are accepted:

1. Welding spots and other welding products have to be removed mechanically.
2. Welding seams have to be made even and grinded.
3. Degreasing with degreasing products based on organic solutions.
4. Pickle with suitable pickling solutions, for instance phosphor acid solution, according to supplier instructions.
5. Careful washing with warm water. No pickle solution is allowed to stay in cracks and hollow areas.
6. Drying and after drying with warm air.

The quality of the surface treatment shall be assessed in accordance with the specifications of the surface treatment supplier before being processed to the paint application.

After complete chemical pre-treatment, the surface provided is deemed ready to use for painting. The work piece surfaces shall be completely dry and clean. If relevant, specific attention shall be paid to the maximum recovery time allowed to start the painting process, according to the recommendations of the surface treatment supplier

### B. Treatments afterwards

1. If pre-treated added on parts shall be welded on other products, the area of the welding seams has to be pre-treated in any case again according to the point A.
2. At the beginning of the application of the anti-corrosion primer, the surfaces have to be clean, free of grease and dry, if necessary the pretreatment has to be fully or partly repeated. Dirt, oil, grease and hand sweat have to be removed with a degreasing substance based on organic solution. Tightly welded or tightly sealed hollow profiles don't get a pre-treatment and painting inside. The use of wire brushes except of brushes, made from stainless steel, is not allowed.
3. Painting is allowed if aluminium surface temperature is 3°C above the dew point temperature (see ISO 8502-4)
4. Painting is allowed if confirmed an absence of soluble contaminants through the method according to ISO 8502-6:
  - Salts <3 µg /cm<sup>2</sup>;
5. Painting is allowed if confirmed absence of dust through the method according to ISO 8502-3 part 3 - Class 0-1 for all types of supports.

### 8.2.4 Pretreatment of stainless steel surfaces to be coated

- a) Dirt, oil, grease and hand sweat have to be removed with a degreasing substance based on organic solution.
-

Stainless steel to be coated surfaces shall be pretreated:

- b) The surfaces shall be pre-treated as follow:
1. Surfaces of products in cold rolled supply conditions have to be ground or blasted. After the mechanical pre-treatment a roughness of  $R_a > 5 \mu\text{m}$  [ $R_z > 19 \mu\text{m}$ ] has to be reached
  2. Surfaces of products in warm rolled supply conditions have to be blasted if they didn't pickled or neutralized;
  3. Glass rolls and mineral blasting cleaning abrasive materials shall be used (content of metallic iron max. 1.0%). The already used grinding materials are not allowed for other materials.
  4. For inner surfaces a mechanical pre-treatment could be give up.
  5. Welding seam areas have to be mechanically treated through in any case (also the inner surfaces). With them welding arrears have to be replaced completely, welding sprayed spots if necessary push away.
- c) Painting is allowed if the surfaces are completely degreased
- d) Painting is allowed if stainless steel surface temperature is 3°C above the dew point temperature (see ISO 8502-4)
- e) Painting is allowed if confirmed an absence of soluble contaminants through the method according to ISO 8502-6:  
- Salts  $< 3 \mu\text{g} / \text{cm}^2$ ;
- f) Painting is allowed if confirmed absence of dust through the method according to ISO 8502-3 part 3 - Class 0-1 for all types of supports

Stainless steel not to be coated surfaces shall be pretreated

Temper colors and all other irregularities which disturb the passive layer must be removed. Treatments for removing the disruption and enable the stainless steel to rebuild a closed chromium-oxide layer shall be obtained by the application of the standard practice ASTM A380. Building of the oxide layer may be natural (exposure as minimum of 2 days in dry ambient without any contaminants) or forced (passivation). After the end of the process passivation all chemical products shall be removed.

**8.2.5 Pretreatment of plastics**

Plastic surfaces (e.g. GRP) are to be washed off before a coating with suitable solvents and are to be roughened within the entire range of the surfaces, planned for coating with sandpaper, usually grain size 240-360, and are to be cleaned.

The solvents are to be selected after arrangement with the manufacturers of the plastic shaped parts regarding a complete removability of the used parting agents.

If on plastics from the serie of the polyolefins, e.g.

Polyethylene (PE)

Polypropylene (PP) or

Polytetrafluorethylene (PTFE)

should be applied paint, glue or lacquer, their smooth surfaces must be made adhesion active by pickling with suitable products, by electrical oxidizing or others suitable methods agreed with the paints manufacturer.

For the cleaning only lint free materials shall be used.

Painting is allowed if stainless steel surface temperature is 3°C above the dew point temperature (see ISO 8502-4);

Painting is allowed if confirmed an absence of soluble contaminants through the method according to ISO 8502-6: -  
Salts  $< 3 \mu\text{g} / \text{cm}^2$ ;

Painting is allowed if confirmed absence of dust through the method according to ISO 8502-3 part 3 - Class 0-1 for all types of supports

---

## 9. Painting System

### 9.1 Preliminary Recommendations

#### 9.1.1 Surfaces Protection

- a) Unprotected metal surfaces, with the exception of aluminium alloy surfaces, shall be protected by a suitable coating system. Aluminium alloy surfaces shall be protected by a suitable coating system except surfaces that are either:
- in an area where a decorative finish is not specified.
  - within the carbody, and are not normally in contact with Passengers and staff; *only the carbody floor, inside and bodysides/endwalls bands up to 100 mm over the floor, shall be protected so as toilette and bistrò area.*
  - inside aluminium alloy hollow extrusions
- ↳
- fully protected from direct exposure to rain and washing plant cleaning fluids.
  - exposed to indirect contact with rain and washing plant cleaning fluids but are self-draining with no potential for liquid entrapment.
- b) Ensure any carbody or other cut outs are fully coated over both sides of the joint area (to a min. of 25mm away from the panel edge), even if the reverse side of the product is not generally painted.

#### 9.1.2 Inner surfaces of hollow spaces

- a) Hollow profiles / cavities must be drained and vented in a suitable manner. Drainage openings shall at least have a diameter of 15 mm at the lowest point.
- b) In case this is not possible, hollow components which are not accessible, shall be sealed off completely and permanently.
- c) The inner surfaces of hollow sections to be caulk-welded (cavities made from steel / welded stainless steel) shall not be coated.
- d) If caulk welding, at the point c), is not possible the inside of the hollow space needs to be treated with suitable protective agents like DINITROL 977 (code: EC02N000629B) or equivalent products.
- Before hollow space treatment can be performed following steps must be done in advance:
  - Application of paint according to required coating structure.
  - Sealing of gaps
- e) Any other safety measures, such as the use of suitable sealing compounds with the corresponding sealing pieces may be required and shall be agreed individually. It must be ensured that the in-process inspections of the sealing works of the corresponding hollow sections are carried out reliably.
-

### 9.1.3 How to fill gaps on overlaps

- a) The gaps on overlappings which cannot be sealed under the specified coating system shall be sealed by a sealant compatible with the painting system, comply with the applicable Fire & Smoke requirements and suitable for the foreseen area.
- b) Sealings shall be made in the areas affected by wetness like:
- the carbody shell outside and parts directly mounted to it,
  - floor area in passenger / driver area, underfloor area
  - gaps between step and spot welding.
- c) Sealings can be avoided:
- If under usual running conditions no wetness is present – e.g. in dry interior areas – no sealing is required.
  - Sealing of gaps between stainless steel parts (only between stainless steel, no other material, min. 1.4307 or better corrosion resistance) is not necessary if they are not exposed to wetness.
  - contact areas from parts to C-rails.
- d) Sealants shall be applied after painting process is finished (after complete curing of paints).
- e) Primer, putty, filler, base coat & clear coat must never be applied on top of sealing materials.
- f) Thicklayer coating, monocoat and pigmented topcoat may be applied on sealing materials after to have tested their adhesion on sealant.
- g) The figure here below shows how the sealant shall be applied in area where a discontinuity of finishing is present. This condition is typical for strength relevant connection areas *thicklayer coating or monocoat* or topcoat shall be covered by the sealant of an overlap of  $\approx 5$  mm.

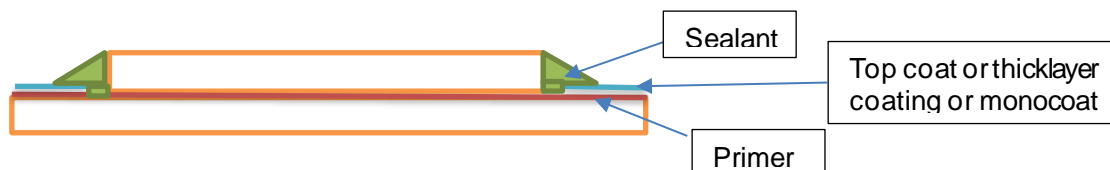

9.1.4 Film thickness

- a) All DFTs shall be taken after sanding operations where it is foreseen
- b) DFTs shall be taken according to the criteria established in the Annex A of the standard NF F 19-141-1. *As partial deviation, the min. and max DFTs, mentioned above, shall be identified as (z) (min. individual reading DFT) and (y) (max. individual reading DFT); (y) value may exceed the limit if the requirement at the point d) is met. The arithmetic mean of all the individual DFT, taken from an inspection area, shall be equal to or greater than the min.DFT (z) DFT measurement shall be performed by the methods defined in the standard ISO 2808; The procedure of the standard ISO 19840 shall be applied for blasted surfaces.*
- c) The location and number of measuring points shall be defined for each painted surface. they shall be identified considering as guideline the following table taken from NF F 19-141-1, Annex A, which report the minimum number of measurement points related to the surface area to be considered:

Area/length of inspection area m <sup>2</sup> or m	Number of Measuring Points
< 1	3 to 10
1 to 10	10 to 20
10 to 100	20 to 50

- d) The dry layer thickness of the total coating structure (components and carbony, without putty areas, without areas with anti-drumming mass/ protective undercoat) *shall not exceed 2.5 times* the value of the minimum dry film thickness.
- e) The maximum dry film thickness of the putty after sanding must be 1 mm or less however, occasionally, on localised areas, to make up for significant flatness defects, this thickness may be more than 1 mm; in this case a specific approval of the Paint manufacturer is request. *The putty mean thickness should be ≤ 300 µm after sanding; higher values are allowed if fire & smoke requirements at the § 9.2.2 are met.*
- f) the DFT of applied paint products, ≤ 100 µm must be increased in the complex area of application. In these difficult areas, local extra thickness values can be tolerated if they do not undermine the required paint product use characteristics.

9.1.5 Coating in connections areas

- g) Unless otherwise specified in the drawings, the contact faces of strength-relevant connections (screwed, bolted or riveted assemblies) shall be coated only with anticorrosion priming, DFT 40÷60 µm (identified by painting system PS00) Any deviations from this general rule required for strength considerations must be defined by the engineer and coordinated with the calculation department
- h) The jointing areas (including pure stainless steel-combinations) must be permanently sealed in a suitable manner against the ingress of moisture or aggressive media to prevent crevice corrosion
- i) Exposed primed surfaces must be treated with the coating system intended for this area after assembly of destined parts.
- j) Fastening elements, in the exposed areas, must be treated at least 5 mm circumferential with corrosion protection agent (except for pure stainless-steel connections (including parts & fastening elements) (DINITROL 977(code: EC02N000629B) or equivalent products);

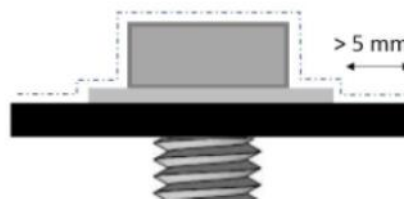



- k) Depending on the location where the only primed surface is located a treatment with a corrosion protection agent (see pont c)) or the painting system intended for this part/area must be used. What must be used must be shown in the (installation) drawing and given in part list. If on parts or systems provided by suppliers such areas are present they must implement the treatment too.
- l) A corrosion protection wax or comparable may be used instead of a coating (only valid for areas not affected by cleaning agents or much moisture) to cover only primed areas.
- m) Stainless steel can remain free of paint (if no design reasons speak against it) except: contact surfaces when mounted to the outside carbody (without underframe housing) unless agreed otherwise.

### 9.1.6 Coating of rail on carbody structure

Treatment of rail for fixation of equipment on Roof (Exterior Vehicle)

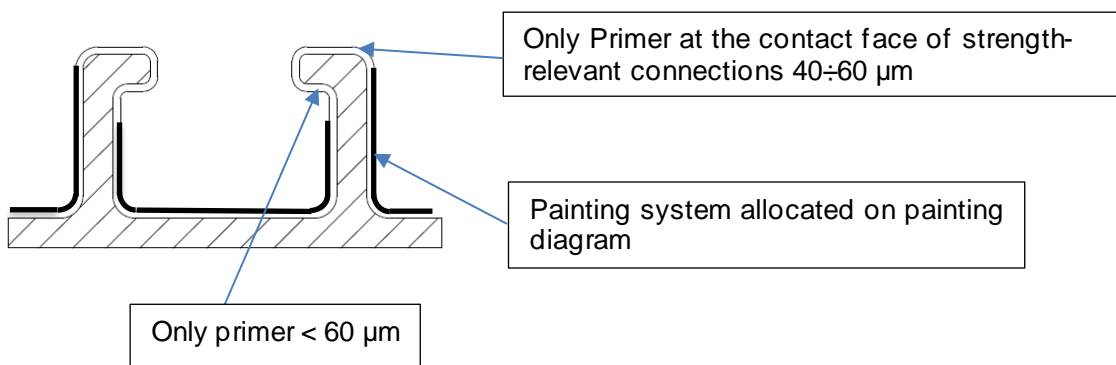

Treatment of rail for fixation of equipment on underframe (Exterior Vehicle)

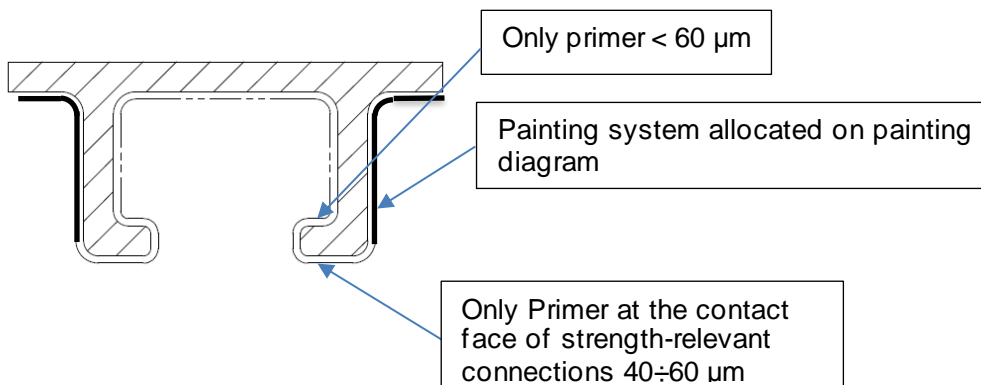

### 9.1.7 Strip Coating

The areas, where it is difficult to apply the painting products by spray (edges, welds, and others irregular or complex areas), shall be treated applying the paint by means of brush before to spray the coat on entire surface. This operation shall be repeated for each coat which form the painting system.

### 9.1.8 Accessibility

All parts, to be painted, should be designed to be accessible for the purpose of applying, inspecting and maintaining the protective paint system (see EN ISO 12944-3, par. 5.2);

As general guideline for the evaluation of the accessibility the following information taken from EN ISO 12944-2, Annex A should be taken into account:

**Table A.1 — Typical distances required for tools in corrosion protection work**

Operation	Length of tool ( $D_2$ ) mm	Distance between tool and substrate ( $D_1$ ) mm	Angle of operation ( $\alpha$ ) degrees (°)
Abrasive blast-cleaning	800	200 to 400	60 to 90
Power-tool cleaning			
— by needle gun	250 to 350	0	30 to 90
— by rubbing/grinding	100 to 150	0	—
Hand-tool cleaning			
— by brushing/chipping	100	0	0 to 30
Metal spraying	300	150 to 200	90
Paint application			
— by spraying	200 to 300	200 to 300	90
— by brush	200	0	45 to 90
— by roller	200	0	10 to 90

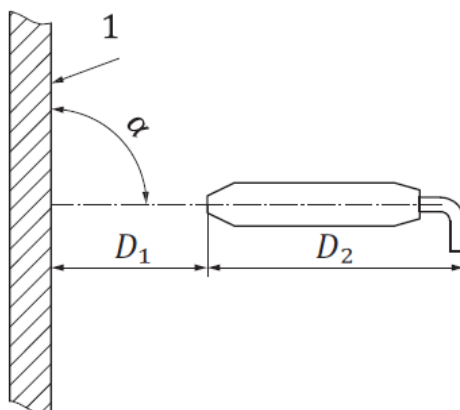

#### Key

- 1 substrate
- $\alpha$  angle of operation
- $D_1$  distance from tool to substrate
- $D_2$  length of tool

**Figure A.1 — Angle of operation and distance from tool to substrate**

### **9.1.9 Surface Flatness**

The surface finish of the external surfaces visible to Passengers shall present a high quality finish that delivers: a smooth and continuous surface free from protuberances, sharp edges, weld spatter or manufacturing marks; a ripple-free appearance when painted or covered in high gloss materials; no undulations on any exterior surfaces exceed 2 mm over 1 m length, excluding Vehicle roof and under frame.

### **9.1.10 Climatic conditions**

To prevent condensation on surfaces to be painted, the object temperature must have acclimatized to the ambient temperature. Records of the processing conditions must be documented. The environmental parameters (temperature, relative humidity) specified in the data sheets of coating materials, sealants & adhesives must be complied during processing.

### **9.1.11 Edges resulting from masking**

Surfaces which are required to be bare (e.g. earthing points) usually need to be masked. After paint application and demasking it can happen, that primer directly below the top coat is visible. This is no defect and is permissible. Furthermore, the edges resulting from the masking process do not need to be leveled.

### **9.1.12 Edges resulting from masking**

In case decorative front side is painted with painting system 1 and non-decorative back side is painted with painting system 2 the overlapping layer (max. 30 mm width) of the two painting systems must be located inside the non-decorative area of the part. . It is advised to first apply the paint system with more flexibility as the application of further layers on top.

### **9.1.13 Repairing Procedure**

Repair must take place with validated wet paint materials acc. to this painting specification.

### **9.1.14 Overspray in not visible area**

Overspray in not visible areas (e.g. carbody sidewall inside above lower edge of passenger window) is permissible if no other requirements are applicable.

---

## 9.2 Painting Systems

### 9.2.1 General

- a) Paints manufacturer shall propose to HR waterborne painting systems. SEC suppliers, for which is valid the condition at the chp. 2 point c), may use solventborne painting system. Thinning by solvent shall be used for primer used to paint GRP.
- b) Powder painting materials shall not be used for external painting of exposed parts; any deviation shall be approved by HR. *Powder painting is allowed for components located in **Zone A3,K3**.*
- c) Within each coating structure only materials of the same paint manufacturer are permissible;
- d) The paints manufacturer, on the basis of the provisions provided in this specification and the indications provided by the documentation mentioned in chp 7, *shall issue a painting work recommendations* with the list of products to be used for each painting system.
- e) Unless otherwise requested, the paint product supplier shall delivery N.15 *master of reference* for each color, in order to be approved by HR. All samples shall be stored in dry and dark environment to prevent aging as far as possible
- f) Unless otherwise requested SEC Suppliers shall deliver N.15 *master sample* for each color. All samples shall be stored in dry and dark environment to prevent aging as far as possible
- g) The paint manufacturer shall report on the master, the gloss measured according to ISO 2813, specifying the angle of the illuminant (\*) and the color coordinates  $L^*, C^*, h^\circ$  and  $L^*, a^*, b^*$ , defined by the CIELab system determined by spectrophotometer with illuminating D65-10° and A-10°, as per standard ISO 11664-4. (\*) the following table shall be taken int account to take the gloss

Gloss level	Observation angle	GU
high-gloss	20°	≥ 80
silk gloss	60°	40-70
silk mat	60°	14-40
mat (lustreless)	60° // 85°	<14 // <40

- h) Metallic colors (e.g. RAL 9006 or RAL 9007) shouldn't be evaluated with measurement equipment. Instead a visual comparison with approved samples should be done.

#### 9.2.1.1 Painting Repairing

- a) Paint manufacturer shall provide painting recommendations for repairing;
- b) Repairing shall be qualified by a test on mock-up or prototype, under identical series process conditions (substrate, pre-treatment, powder, film-thickness, curing conditions etc.); in order to check the finishing (color differences, gloss, thickness, adhesion performances as per section 10.3. This test shall be performed damaging the coating down to the substrate and applying the repairing work instruction.
- c) As regard the powder painting system repaired with wet paint, proceed as per point b) above and perform tests according to section 10.4. Unless otherwise agreed, corrosion tests shall be performed (AASS or NSS test).

#### 9.2.2 Fire Behaviour

All painting systems shall satisfy the requirements defined in the standard EN 45545-2:2015 HL2: R1 for inside vehicle and R7 for outside vehicle; (see par. 4.2, points f), g), i), j), k) of the standard shall be considered).

The Fire & Smoke testing shall be performed by an independent, accredited (ISO 17025) laboratory

## 9.2.3 Painting System Structure

Painting System		Coat 1 (Function) min and max. DFT [ $\mu\text{m}$ ]	Coat 2 (Function) min and max. DFT [ $\mu\text{m}$ ]	Coat 3 (Function) min and max. DFT [ $\mu\text{m}$ ]	Coat 4 (Function) min and max. DFT [ $\mu\text{m}$ ]
Type	Code				
IO-050-PS-TYPE A	PS00	2K-EP Primer (Contact faces) 40÷60			
	PS01	2K-EP Primer 80÷100			
IO-050-PS-TYPE B	PS03	2K-EP Primer 80÷100	PUR Top Coat Antigraffiti 50÷70		
IO-050-PS-TYPE C	PS07	2K-EP Primer 80÷100	Top Coat Antiskid		
	PS05	2K-EP Primer 80÷100	Elasticized EP Top Coat 140÷160		
IO-050-PS-TYPE D	PS09	2K-EP Primer 80÷100	EP Filler <sup>(a)</sup> 80÷150	PUR Top Coat Antigraffiti 50÷70	
	PS11	2K-EP Primer 80÷100	PUR Filler <sup>(a)</sup> 60÷80	PUR Top Coat Antigraffiti 50÷70	
IO-050-PS-TYPE G	PS14	2K-EP Primer 80÷100	PUR Basecoat Antigraffiti 15÷25	PUR Clear Coat Antigraffiti 40÷70	
IO-050-PS-TYPE M	PS19	2K – Monolayer 120÷150			
IO-050-PS-TYPE H	PS15	2K-EP Primer 80÷100	EP Filler (a) 80÷150	PUR Basecoat Antigraffiti 15÷25	PUR Clear Coat Antigraffiti 40÷70
	PS16	2K-EP Primer 80÷100	PUR Filler <sup>(a)</sup> 60÷80	PUR Basecoat Antigraffiti 15÷25	PUR Clear Coat Antigraffiti 40÷70
IO-050-PS-TYPE N	PP01	EP Primer 60÷80	Antigraffiti Solid Top Coat 60÷80		
IO-050-PS-TYPE P	PP03	Antigraffiti Solid Top Coat 60÷80			

**Notes:**

- a) Where necessary, surfaces flatness, shall be obtained by the application of EP or UP putty;. After the application of the putty and sanding operations, **the min.DFT of the EP primer shall be guaranteed.**
- b) The use of a polyester putty is allowed to make the touch-up in order to remove small defects before to apply the finish layer.
- c) DFTs may be adjusted after the selection of the painting products; deviations shall be agreed with HR;

### 9.2.4 Painting System Allocation

Allocation of painting systems here below is based on document EC100016475.

*Table 1 - Exterior Carbody Structure and Parts added on*

ID	Location	Vehicle Section to painted	Substrate
			Aluminium Alloy
01	Zone D – External: exposed, in visual contact	Bodyside	PS16
02	Zone A1 – External: exposed, not in visual contact, exposed to solar radiation	Roof	PS03; PS07 (where applicable)
03	Zone D – External: exposed in visual contact	Rear End	PS16
04	Zone A2 – External: exposed not in visual contact and not exposed to solar radiation	Front End Structure	PS05
05	Zone A3 -External: not exposed and not in visual contact; not exposed to solar radiation	Underframe	PS05

*Table 2 - Interior Carbody Structure and Parts added on*

ID	Location	Vehicle Section to painted	Substrate	
			Aluminium Alloy	Note
01	Zone I – not exposed, not in visual contact	Bodyside	PS01	As indicate in the painting diagram
02	Zone I – not exposed, not in visual contact	Roof	PS01	As indicate in the painting diagram
03	Zone I – not exposed, not in visual contact	Rear End	PS01	As indicate in the painting diagram
04	Zone I – not exposed, not in visual contact	Front End Structure	PS01	As indicate in the painting diagram
05	Zone A2 – exposed, not in visual contact not exposed to solar radiation	Underframe	PS19	

*Table 3 - Equipment and their parts (frames, boxes, skirts, coverings, brackets, panels)*

ID	Zone	Substrate		
		Aluminium Alloy	Steel	Composites
01	K1	PS09 or PS15 or PS14 or PS15	PS09 or PS15 or PS14 or PS15	PS09 or PS15 or PS14 or PS15
02	K2	PS05	PS05	PS05
03	K3	PS03 or PP03	PS03 or PP01	PS03 or PS15
04	D	PS16	PS16	PS16

## 10. QUALIFICATION

### 10.1 Painting System Qualification

- a) Qualification of the painting system shall be proved by the release of a test plan based on the tables in the following sections and test reports which shall contain the following information:
- substrate material including thickness of each layer.
  - substrate material preparation/pre-treatment of surface
  - tempering conditions / forced drying before (if present) and after painting application.
  - material identification (incl. article and batch number) and dry layer thicknesses of each coating
  - a reference to the respective standard
  - the process time between manufacturing, coating, testing and evaluation.
  - shape, size and number of specimens used.
  - date of inspection
  - test conditions deviating from the standard or additional test conditions which may influence the test result.
  - pictures: before and directly after the testing
- b) HR may request samples to perform matching tests.
- c) For sample plates – especially GRP – it is advised to cover the edges (transition area between painted and non-painted area) with a suitable tape to avoid edge effects influencing the test results .
- d) Samples to be tested shall be painted according to the painting instruction that shall be adopted during the manufacturing of the serial production. DFT shall meet the requirement at the section 9.1.4. Physical properties shall be performed with an average DFT close to the max DFT, all the others tests close to the min. DFT.
-

## 10.1.1 Painting System Zone D – Test List

- a) **Table 1: Each painting system used to paint Zone D** (see § 9.2.4) shall comply with the following requirements (DFT according to those specified in the work instruction)

ID	PROPERTY	TEST DESCRIPTION	TTS	TEST METHOD	TEST CONDITION	Acceptance Criteria
00	Structure configuration	Inspection	-	-	-	To be provided master of reference (see definition at chp. 3) for approval
01	Physical Properties	Adhesion (cross cut; X-test)		ISO 2409; ISO 16276-2	For DFT $\geq$ 250 $\mu$ m perform X-test Test to be performed on all substrates Tape: Tesa 4124 (Clear)	Class 0; Level 0
02		Adhesion (Pull Off)		ISO 4624	A minimum of three dollies in the selected area of test shall be pulled off. Test to be performed on all substrates	$\geq$ 3MPa, failure type A/B not allowed; (unless pull-off values are at least 5 MPa) $\geq$ 2.5MPa, failure type A/B not allowed (failures cohesive or adhesive at the others intercoating are allowed) $\geq$ 1.5MPa, failure type A/B not allowed; for the others only cohesive failures are allowed
03		Hardness	TTS 2864	ISO 1522 ISO 2815	Substrate: Q panel type R and AQT	$\geq$ 100 s $\geq$ 85
04		Impact - Falling Weight	TTS 2864	ISO 6272-1	1kg, height: 100 cm; Substrate: Q panel type R and AQT	No cracking, flaking, intercoat adhesion failure or delamination from the substrate. Visual Inspection by naked eye
05		Impact - Falling Weight (Inverse)	TTS 2864	ISO 6272-1	1kg, height: 50 mm; Substrate: Q panel type R and AQT	No cracking, flaking, intercoat adhesion failure or delamination from the substrate. Visual Inspection by naked eye
06		Resistance to the Bending	TTS 2864	ISO 1519	Mandrel diameter: 6 mm; Substrate: Q panel type R and AQT	No cracking, Flaking, delamination intercoat adhesion failure. Visual Inspection by naked eye
07		Resistance to deformation by Indentation (cupping test)	TTS 2864	ISO 1520	Test depth: 5 mm; Substrate: Q panel type R and AQT	No cracking, Flaking, delamination intercoat adhesion failure. Visual Inspection by naked eye
08		Chipping Resistance	TTS 2864	ISO 20567-1	Method B Substrate: AA series 6082 T6, thick 2 mm; Steel S235 JR or J2 EN 10025, 1mm	Assessment Criteria: Rating $\leq$ 1.5 Not allowed primer removal
09		Resistance to the Abrasion	TTS 2864	EN ISO 7784-2	Grinder CS 10 – 1000 Cycles – 1 kg. Substrate: Q panel type R and AQT	Weight Loss < 0.06g
10		Scratch Resistance	TTS 2864	EN ISO 1518-1	20N counterweight and scratch stylus D; Load: 2.5 kg Steel S235 JR or J2 EN 10025, 1mm	There shall be no penetration of the paint system.
11		Washer brushes Resistance	TTS 1216	ISO 20566	Substrate: AA series 6082 T6, thick. 2 mm	Gloss retention $\geq$ 93% (comparison with not tested sample) Gloss at 60°, after 5, 10 and 20 cycles



ID	PROPERTY	TEST DESCRIPTION	TTS	TEST METHOD	TEST CONDITION	Acceptance Criteria
12	Chemical Resistance and Cleanability	Resistance to Liquids	TTS886	ISO 2812-1 Method A	a) Sulfuric acid at 3% in water solution at 20°C; exposure: 72 h b) Caustic soda at 3% in water solution at 20 °C: exposure 48 h Substrate: AA series 6082 T6, thick. 2 mm; Steel S235 JR or J2 EN 10025, 1mm	Not visible alteration between samples exposed and not exposed; No softening, no swelling, no cracking, flaking, wrinkling, no blistering Visual Inspection by naked eye Adhesion to be taken 24 h from the end fo the exposure- Class 0 – ISO 2409
13		Resistance to Water Immersion	TTS 886	ISO 2812-2	40°C -720 h – No scribe (ISO A4) Substrate: AA series 6082 T6, and 5083 H32 thick. 2 mm; Steel S235 JR or J2 EN 10025, 1mm, and GRP (cab hood) when coating GRP / Gelcoat a 30 mm stripe must remain free of coating; after coating of each layer a stripe of minimum 30 mm width must be covered on the short side of the samples	After 24 h of the end of exposure, no softening, no swelling; no cracking, flaking, wrinkling, no blistering After 24 h Adhesion ISO 2409: ≤ Class 0-1 After 24 h Adhesion ISO 4624: ≥ 1.5 MPa
14		Resistance to the Cleaning products	TTS 886	ISO 2812-3 or ISO 2812-4	Exposure to chemical agents: 24 h; Unless otherwise agreed, the list of chemical agents shall be proposed by painting manufacturer Substrate: AA series 6082 T6, thick. 2 mm; Steel S235 JR or J2 EN 10025, 1mm	Not visible alteration between samples exposed and not exposed; No softening, no swelling, no cracking, flaking, wrinkling, no blistering Visual Inspection by naked eye Colour: $\Delta E_{00} \leq 1.5$ ISO 11664-6 Gloss retention $\geq 93\%$ (comparison with not exposed sample)
15		Resistance to the Graffiti Removal	TTS 886	EC07P023203B	Method D Substrate: AA series 6082 T6, thick. 2 mm	As per HR specification
16		Compatibility with decals and labels	Decals Removability	TTS 1217 TTS 746		Decals, Labels and sign shall be removed according to the removal procedure, (adhesive residuals shall be completely removed) after the exposure at 70°C for 14 days (removal after 2h at room temperature from the end of exposure); Samples dimensions based on max. dimensions of labels and sign; Labels shall be applied on samples painted with the same painting system adopted for the area where the label will be installed. Substrate: AA series 6082 T6, thick. 2 mm

ID	PROPERTY	TEST DESCRIPTION	TTS-	TEST METHOD	TEST CONDITION	Acceptance Criteria
17	Long Term Durability	Resistance to Cyclic Corrosion Conditions	TTS 1216	ISO 11997-1	Cycle B – 6 cycles; sample dimensions (ISO A4) Make a straight scratch or scribe mark through the coating to the substrate Substrate: AA series 6082 T6 and 5083 H32 thick. 2 mm; Steel S235 JR or J2 EN 10025, 1mm and GRP (see ID 18)	ISO 4628-2: 0(S0) Blistering ISO 4628-3: Ri 0 - Rusting ISO 4628-4: 0 (S0) - Cracking ISO 4628-5 0 (S0) - Flaking ISO 4628-8: c and d ≤ 2 mm (to be verified after 24 h after the end of the exposure);
18		Resistance to the Humidity	TTS 1216	ISO 6270-2 (CH)	Exposure 720 h; sample dimensions (ISO A4) Substrate: AA series 6082 T6 and 5083 H32 thick. 2 mm; Steel S235 JR or J2 EN 10025, 1mm and GRP when coating GRP / Gelcoat a 30 mm stripe must remain free of coating; after coating of each layer a stripe of minimum 30 mm width must be covered on the short side of the samples	ISO 4628-2: 0(S0) Blistering Adhesion: ≤ Class 1 ISO 2409 (after 24 h)
19		Thermal Shock	TTS 1216	ISO 9142	Exposure at 20 cycles: sample dimensions (ISO A4) 4 hours at -40°C 2 hours water immersion at 23 °C 3 hours at -40°C 15 hours at 60°C Substrate: AA series 6082 T6, thick. 2 mm; Steel S235 JR or J2 EN 10025, 1mm	Not visible alteration with naked eye (comparison with not exposed sample); No Cracking, Flaking; blistering; Chalking, softening, delamination
20		Resistance to the Weathering	TTS 1216	ISO 16474-2	Irradiance narrowband A 340nm: 0.51 ±0.02 W/(m <sup>2</sup> ·nm) Black standard temperature: 65°C ±3 °C (102 min dry) Chamber temperature: 38°C ±3 °C (102 min dry) RH: 50% ±10 % (102 min dry) Cycle: 102 min dry/18 min water spray Exposure time: 2000 h - (480 MJ/m <sup>2</sup> at 340 nm) Borosilicate S Filters Internal and external Substrate: AA series 6082 T6, thick 2 mm;	Not visible alteration; (comparison with not exposed sample) No Cracking; Flaking; blistering; Chalking, no softening, no delamination Visual Inspection by naked eye Colour: ΔE <sub>00</sub> : ≤ 1.5 ISO 11664-6 Gloss retention ≥ 93% (comparison with not exposed sample)
21		Resistance to Salt Spray (NSS for steel and AASS for Aluminium Alloy)			ISO 9227	Exposure time 1000 h; sample dimensions (ISO A4) Make a straight scratch or scribe mark through the coating to the substrate Substrate: AA series 6082 T6, thick 2 mm and 5083 H32; Steel S235 JR or J2 EN 10025, 1mm

**Notes:**

Painting System already tested, according to the table above, are accepted; if some tests are missing, they shall be performed only if no others test more restrictive have been performed.

## 10.1.1.1 Painting System with putty

As indicated in the section 9.2.3; the surfaces flatness can be obtained applying the putty; all painting system which foreseen the adding of the putty, shall meet the requirements in the table here below.

ID	TEST DESCRIPTION	TEST METHOD	TEST CONDITION	Acceptance Criteria
01	Adhesion test (Pull off)	ISO 4624	A minimum of three dollies in the selected area of test shall be pulled off; Test to be performed with the following Putty thick. 500, 1000 µm	≥ 1.5MPa, failure type A/B not allowed; for the others only cohesive failures are allowed
02	Resistance to the Bending (*)	F341 NF F 19-201	Mandrel diameter: 100 mm; Test to be performed with the following Putty thick. 500 and 1000 µm Substrate; Q-Panel type R	No cracking, flaking, intercoating adhesion failure, delamination; Visual Inspection by naked eye
03		ISO 6860	Test to be performed with the following Putty thick. 500 and 1000 µm Substrate; Q-Panel type R; positioning the sample at the side of diameter 38 mm. Angle of bending: 15°	No cracking, flaking, intercoating adhesion failure, delamination; Visual Inspection by naked eye
04	Resistance to the Humidity	ISO 6270-2 (CH)	Exposure 720 h Substrate: AA series 6082 T6, thick. 2 mm	ISO 4628-2: 0(S0) Blistering
05	Thermal shock	ISO 9142	Exposure at 20 cycles: 4 hours at -40°C 2 hours water immersion at 23 °C 3 hours at -40°C 15 hours at 60°C Substrate: AA series 6082 T6, thick. 2 mm;	Not visible alteration with naked eye (comparison with not exposed sample); No Cracking, flaking, blistering, chalking, no softening.
06	Compatibility with decals and labels		Decals, Labels and sign shall be removed according to the removal procedure, (adhesive residuals shall be completely removed) after the exposure at 70°C for 14 days (removal after 2h at room temperature from the end of exposure); Samples dimensions based on max. dimensions of labels and sign; Labels shall be applied on samples painted with the same painting system adopted for the area where the label will be installed. Substrate: AA series 6082 T6, thick. 2 mm	Not visible alteration respect to a sample without decals and not exposed; No softening, no swelling, no cracking, flaking, wrinkling, no blistering Visual Inspection by naked eye

(\*) a test method should be selected.

### 10.1.2 Painting System Zone A1,K1 – Test List

Painting systems **used to paint** component located in **Zone B** shall meet the requirements in the table at the section 10.1.2., except: ID 10,11,15,16.

Painting System already tested, according to the table at the sect 10.1.1, are accepted; if some tests are missing they shall be performed only if no others test more restrictive have been performed.

### 10.1.3 Painting System Zone A2,K2 – Test List

Painting systems used to paint component located in Zone C shall meet the requirements in the table at the section 10.1.2 except: ID 10,11,15,16,20

Painting System already tested, according to the table at the sect 10.1.1 are accepted; if some tests are missing they shall be performed only if no others test more restrictive have been performed.

### 10.1.4 Painting System Zone A3,K3 – Test List

As partial deviation to table at the section 10.1.1, long term durability tests for painting system used to paint component located in Zone C, are those reported in the table here below:

ID	TEST DESCRIPTION	TEST METHOD	TEST CONDITION	Acceptance Criteria
A	Resistance to the Salt Spray	ISO 9227 NSS	Exposure time 480 h Make a straight scratch or scribe mark through the coating to the substrate Substrate: AA series 6082 T6, thick. 2 mm; Steel S235 JR or J2 EN 10025, 1mm	ISO 4628-2: 0(S0) Blistering ISO 4628-3: Ri 0 - Rusting ISO 4628-4: 0 (S0) - Cracking ISO 4628-5 0 (S0) - Flaking ISO 4628-8: c and d ≤ 2 mm (to be verified after 24 h after the end of the exposure)
B	Resistance to the Salt Spray	ISO 9227 AASS	Exposure time 480 h Make a straight scratch or scribe mark through the coating to the substrate Substrate: AA series 6082 T6, thick. 2 mm	ISO 4628-2: 0(S0) (Blistering) ISO 4628-8: ISO 4628-8: c and d ≤ 3 mm (to be verified after 24 h after the end of the exposure);
C	Resistance to the Humidity	ISO 6270-2 (CH)	Exposure 240 h Substrate: AA series 6082 T6, thick. 2 mm; Steel S235 JR or J2 EN 10025, 1mm	ISO 4628-2: 0(S0) Blistering Adhesion: ≤ Class 1 ISO 2409 (after 24 h)

### 10.1.5 Anticorrosion Primer Requirements

Anticorrosion primer shall guarantee the following performances (DFT according to the one specified in the work instruction):

ID	PROPERTY	TEST DESCRIPTION	TEST METHOD	TEST CONDITION	Acceptance Criteria
01	Physical Properties	Adhesion (Cross Cut)	ISO 2409	On all substrates	Class 0
02		Adhesion (Pull Off)	ISO 4624	On all substrates	≥ 3MPa, failure type A/B not allowed; (unless pull-off values are at least 5 MPa)
03		Resistance to the Bending	ISO 1519	Mandrel diameter: 6 mm Q panel type R	No cracking, No Flaking, No delamination (ISO 4628-4-5-8); Visual Inspection by naked eye
02		Resistance to deformation by Indentation (cupping test)	ISO 1520	Test depth: 5 mm Q panel type R	No cracking, No Flaking, No delamination (ISO 4628-4-5-8) Visual Inspection by naked eye
03		Impact test	ISO 6272-1	1kg from 1 m Q panel type R	
04	Long term durability	Resistance to the Humidity	ISO 6270-2 (CH)	Exposure: 1000 h Substrate: AA series 6082 T6, and 5083 H32 thick. 2 mm; Steel S235 JR or J2 EN 10025, 1mm	Blistering: 0(S0) ISO 4628-2 Adhesion cross cut (ISO 2409) - After 24 h: Class 0-1
05		Resistance to the Salt Spray	ISO 9227 AASS	Exposure time 1000 h Make a straight scratch or scribe mark through the coating to the substrate Substrate: AA series 6082 T6, thick. 2 mm	ISO 4628-2: 0(S0) (Blistering) degree of delamination acc. ISO 4628-8 ISO 4628-8: c and d ≤ 3 mm (to be verified after 24 h after the end of the exposure);
06		Resistance to the Salt Spray	ISO 9227 NSS	Exposure time 1000 h Make a straight scratch or scribe mark through the coating to the substrate Substrate: AA series 6082 T6, thick. 2 mm; Steel S235 JR or J2 EN 10025, 1mm	ISO 4628-2: 0(S0) Blistering ISO 4628-3: Ri 0 - Rusting ISO 4628-4: 0 (S0) - Cracking ISO 4628-5 0 (S0) - Flaking ISO 4628-8: c and d ≤ 2 mm (to be verified after 24 h after the end of the exposure)

Anticorrosion primer which meets the requirements in the table above, already tested under the same or more stringent conditions respect to those here requested, can be accepted.

## 10.1.6 Powder Painting System

ID	PROPERTY	TEST DESCRIPTION	TTS	TEST METHOD	TEST CONDITION	Acceptance Criteria
00	Structure configuration	Inspection	-	-	-	To be provided master of reference (see definition at chp. 3) for approval
01	Physical Properties	Adhesion (cross cut; X-test)		ISO 2409;	Test to be performed on all substrates Tape: Tesa 4124 (Clear)	Class 0;
02		Adhesion (Pull Off)		ISO 4624	A minimum of three dollies in the selected area of test shall be pulled off. Test to be performed on all substrates	≥ 2.5MPa, failure type A/B not allowed, if present the primer (failures cohesive or adhesive at the intercoating are allowed) ≥ 1.5MPa, failure type A/B not allowed; cohesive failures are allowed
03		Wet adhesion			Testing in boiling, de-ionized water (max. 30 μS at 20°C) for 120 min. Take the sample out of the boiling water and store on room temperature.	On visual inspection, there shall be no sign of detachment or blistering. Colour change is acceptable. Adhesion test ISO 2409 after 1 hour of storage: Class ≤ 1
04		Impact - Falling Weight		ISO 6272-1	1kg, height: 25 cm; Substrate: Q panel type AQT for Alu. alloy; Substrate: Q panel type R for Steel	No cracking, spalling, intercoat adhesion failure or delamination from the substrate. Visual Inspection by naked eye
06		Resistance to the Bending		ISO 1519	Mandrel diameter: 5 mm; Substrate: Q panel type R for steel Substrate: Q panel type AQT for Alu. Alloy	No cracking, spalling, intercoat adhesion failure or delamination from the substrate. Visual Inspection by naked eye
07		Resistance to deformation by Indentation (cupping test)		ISO 1520	Test depth: 5 mm; Substrate: Q panel type AQT for Alu. Alloy Substrate: Q panel type R for Steel	No cracking, spalling, intercoat adhesion failure or delamination from the substrate. Visual Inspection by naked eye
08		Chemical Resistance and Cleanability	Resistannce to the Cleaning products		ISO 2812-3 or ISO 2812-4	Exposure to chemical agents: 24 h; Unless otherwise agreed, the list of chemical agents shall be proposed by painting manufacturer Substrate: AA series 6060 or 6063, thick. 2 mm or Steel S235 JR or J2 EN 10025, 1mm

ID	PROPERTY	TEST DESCRIPTION	TTS	TEST METHOD	TEST CONDITION	Acceptance Criteria
08	Long term durability	Resistance to the Humidity		ISO 6270-2 (CH)	Exposure: 600 h Substrate: aluminium alloy series 6082 T6; surface pretreatment as used for production Substrate: Steel S235 JR or J2 EN 10025, 1mm surface pretreatment as used for production; Substrate; AA series 6060 or 6063 surface pretreatment as used for production	Blistering: 0(S0) ISO 4628-2 Adhesion cross cut (ISO 2409) - After 24 h: Class 0-1
09		Resistance to the Salt Spray		ISO 9227 AASS	Exposure time 1000 h Make a straight scratch or scribe mark through the coating to the substrate Substrate; AA series 6060 or 6063 surface pretreatment as used for production	ISO 4628-2: 0(S0) (Blistering) degree of delamination acc. ISO 4628-8 surface delamination: ≤ 16mm <sup>2</sup> (over a scratch length of 10 cm) longest delamination: ≤ 4mm
10		Resistance to the Salt Spray		ISO 9227 NSS	Exposure: 1000 h Substrate: Steel S235 JR or J2 EN 10025, 1mm surface pretreatment as used for production	ISO 4628-2: 0(S0) Blistering ISO 4628-3: Ri 0 - Rusting ISO 4628-4: 0 (S0) - Cracking ISO 4628-5 0 (S0) - Flaking ISO 4628-8: c ≤ 1 mm and d ≤ 2 mm (to be verified after 24 h after the end of the exposure)

Alternatively, to above mentioned tests the membership of an officially recognized quality association will be accepted. In this case the powder coater needs to handover a valid license certificate from one of below listed organizations:

- QIB: Aluminum and steel interior, at least stress group II; Aluminum and steel exterior = stress group IV or higher
- Qualicoat: Aluminum Interior or Exterior
- GSB International: QR 631 Aluminum interior/exterior
- DBS 918 340
- NF F 19-477

## 10.2 Labels and Signage

a) The requirements below listed, are applicable to labels, decals and signage and not to the painting materials.

ID	PROPERTY	TEST DESCRIPTION	TTS-HS - Req ID	TEST METHOD	TEST CONDITION	Acceptance Criteria
01	Chemical Resistance and Cleanability	Resistance to the Cleaning products	TTS 886	ISO 2812-3 or ISO2812-4	Exposure to chemical agents: 24 h; Unless otherwise agreed, the list of chemical agents shall be proposed by labels and decals supplier Substrate: film applied on painted surfaces, painting system PS11 and PS11 with putty	No visible difference between samples exposed and not exposed; No softening, no swelling, no others damages Visual Inspection by naked eye
02		Resistance to the Graffiti Removal	TTS 886	EC07P023203B	Method C Substrate: film applied on painted surfaces, painting system PS11 and PS11 with putty	As per HR specification
03	Label Signage Removal	Labels Removability	TTS 745	EN 1939	Method 4 Substrate: film applied on painted surfaces, painting system PS11	$6\text{ N} \leq \text{value} \leq 10\text{ N}$

b) Painting products already tested under the same or more stringent conditions respect to those request in the above table, can be accepted.



### 10.3 Painting Process Qualification – Wet Paint

1. Make a prototype or mock-up or first piece painted according to the applicable work instruction used during the production (one for each substrate material to be painted)
2. Curing time of the applied painting system (21 days for wet paint and 14 days for solvent paint); if agreed with the Paint manufacturers, curing time can be reduced using higher drying temperature.
3. Perform the following checks & tests for each used painting system (included that with putty):

ID	Test & Checks Description	Test Method	Test Condition	Acceptance Criteria
01	Color	ISO 11664-4	According to VDB guidelines Color Measurement will be carried out with a photo spectrometer. It will be measured on 4 different locations on the colored surface ( in a typical 1m <sup>2</sup> area), the average value is given as the inspection result and recorded.	Visual comparison to a master sample (see definition at chp 3) to be used as standard method of inspection; Measured color difference, $\Delta E_{00}$ according to ISO 11664-6 $\leq 1,5$ (not applicable to metallic color)
	Gloss	ISO 2813		According to VDB guidelines
02	Surface Quality	VDB Guideline	Inspection conditions as per VDB guideline with the following remarks: Assessment Time of observation (10 seconds per m <sup>2</sup> ) Viewing Conditions (Platform height where possible) Illumination level must be at least 500 lux Viewing Distance – 1m for exterior, 0.5m for interior	According to VDB guidelines; Visual comparison to a master sample (see definition at chp 3) where applicable. As regard the orange peel, the signed panels shall be defined by an orange peel rating based on ACT test panels. If the parties not agree with the assessment of the orange peel; a DOI measurement will be performed (Reference value taken from previous components accepted from the parties)
03	Dry film Thickness	ISO 2808; ISO 19840	All DFT specified in the Painting Instruction shall be taken.	Within the range reported in the Work Instruction If necessary "Paint borer" thick. gauge can be used (destructive test)
04	Curing level	ASTM D5402	Solvent: MEK or Acetone (others solvents may be agreed, if the solvent is not suitable for the paint) Saturate a swab of cotton wool with solvent. Within 30 seconds, rub it lightly back and forth 50 times in each direction over the part to be tested. Wait 30 minutes before making the assessment.	No paint color shall transfer to the cloth. After 72 h, Scratch resistance H $\div$ 2H according to ASTM D 3363; and Gloss within the range of acceptance
04	Adhesion (Cross Cut or X-Test)	ISO 2409		Class 0
		ISO 16276-2	applicable for DFT $\geq 250 \mu\text{m}$	Level 0
05	Adhesion (Pull-Off)	ISO 4624	A minimum of three dollies in the selected area of test shall be pulled off. Test to be performed on all substrates	$\geq 3\text{MPa}$ , failure type A/B not allowed; (unless pull-off values are at least 5 MPa) $\geq 2.5\text{MPa}$ , failure type A/B not allowed (failures cohesive or adhesive at the others intercoating are allowed) $\geq 1.5\text{MPa}$ , failure type A/B not allowed; for the others only cohesive failures are allowed
06	Humidity test	ISO 6270-2 CH	Test to be performed Exposure 240 h Substrate; same material, of the parts, painted according to work instruction used for manufacturing the series production	Blistering 0(S0) ISO 4628-2 Adhesion: $\leq$ Class 1 ISO 2409 (after 1 h) Adhesion: $\leq$ Class 0 ISO 2409 (after 24 h)

ID	Test & Checks Description	Test Method	Test Condition	Acceptance Criteria
07	Resistance to the Salt Spray	ISO 9227 NSS	Exposure time 1000 h for Zone D,A1,K1,A2,K2 Exposure time 480 h for Zone A3,K3 and D (interior) Make a straight scratch or scribe mark through the coating to the substrate Substrate; same material, of the parts, painted according to work instruction used for manufacturing the series production	ISO 4628-2: 0(S0) Blistering ISO 4628-3: Ri 0 - Rusting ISO 4628-4: 0 (S0) - Cracking ISO 4628-5 0 (S0) - Flaking ISO 4628-8: c and d $\leq$ 2 mm (to be verified after 24 h after the end of the exposure)

## Notes:

- a) Tests ID 06 and 07 shall be performed on test samples to perform a correct exposure in the chambers for testing. Shape and dimensions shall be approved by the laboratory; DFT on these samples shall be at the lower limit of the allowable range defined in the work instruction.
- b) Test ID 06 and 07 can be omitted, if already performed during painting system qualification on the substrate here request.

## 10.4 Painting Process Qualification – Powder Paint

1. Make prototype or mock-up or first piece painted according to the applicable work instruction used during the production (one for each substrate material to be painted)
2. After complete curing time of the painting system, perform the following checks & tests for each used painting system:

ID	Test & Checks Description	Test Method	Test Condition	Acceptance Criteria
01	Color	ISO 11664-4	According to VDB guidelines Color Measurement will be carried out with a photo spectrometer. It will be measured on 4 different locations on the colored surface ( in a typical 1m <sup>2</sup> area), the average value is given as the inspection result and recorded.	Visual comparison to a master sample (see definition at chp 3) to be used as standard method of inspection; in case of use of photo spectrometer following criteria shall be applied $\Delta E_{00}$ according to ISO 11664-6 $\leq 2$ (not applicable to metallic color)
	Gloss	ISO 2813		According VDB guidelines
02	Surface Quality	VDB Guideline	Inspection conditions as per VDB guideline with the following remarks: Assessment Time of observation (10 seconds per m <sup>2</sup> Viewing Conditions (Platform height where possible) Illumination level must be at least 500 lux Viewing Distance – 1m for exterior, 0.5m for interior	According to VDB guidelines; Visual comparison to a master sample (see definition at chp 3) where applicable. As regard the orange peel, the signed master sample shall be defined by an orange peel rating based on ACT test panels. If the parties not agree with the assessment of the orange peel by the method above;a DOI measurement will be performed (Reference value taken from previous components accepted from the parties)
03	Dry film Thickness	ISO 2808; ISO 2360	Primer and Total DFT will be taken	Within the range reported in the Work Instruction
04	Curing level	ASTM D5402	Solvent: MEK or Acetone (others solvents may be agreed, if the solvent is not suitable for the paint). Saturate a swab of cotton wool with solvent. Within 30 seconds, rub it lightly back and forth 30 times in each direction over the part to be tested. Wait 30 minutes before making the assessment.	No perceptible change. cannot be scratched with a finger-nail.
05	Adhesion	ISO 2409		Class 0
06	Wet Adhesion	ISO 2409	Testing in boiling, de-ionized water (max. 30 $\mu$ S at 20°C) for 120 min. Take the sample out of the boiling water and store on room temperature.	On visual inspection, there shall be no sign of detachment or blistering. Colour change is acceptable. Adhesion test ISO 2409 after 1 hour of storage: Class $\leq 1$
07	Adhesion (Pull Off)	ISO 4624	Ensure to cut around circumference of the dolly through to the substrate A minimum of three dollies in the selected area of test shall be pulled off.	$\geq 2.5$ MPa, (failures cohesive or adhesive at the others intercoating are allowed) $\geq 1.5$ MPa; (for the others only cohesive failures are allowed)

ID	Test & Checks Description	Test Method	Test Condition	Acceptance Criteria
08	Resistance to the Salt Spray	ISO 9227 AASS	Exposure time 1000 h for Zone D,A1,K1,A2,K2 Exposure time 480 h for Zone A3,K3 and D (interior) Make a straight scratch or scribe mark through the coating to the substrate AA Substrate; same material, of the parts, painted according to work instruction used for manufacturing the series production	ISO 4628-2: 0(S0) (Blistering) degree of delamination acc. ISO 4628-8 surface delamination: $\leq 16\text{mm}^2$ (over a scratch length of 10 cm) longest delamination: $\leq 4\text{mm}$
09	Resistance to the Salt Spray	ISO 9227 NSS	Exposure time 1000 h for Zone D,A1,K1,A2,K2 Exposure time 480 h for Zone A3,K3 and D (interior) Steel Substrate:same material, of the parts, painted according to work instruction used for manufacturing the series production	ISO 4628-2: 0(S0) Blistering ISO 4628-3: Ri 0 - Rusting ISO 4628-4: 0 (S0) - Cracking ISO 4628-5 0 (S0) - Flaking ISO 4628-8: $c \leq 1\text{ mm}$ and $d \leq 2\text{ mm}$ (to be verified after 24 h after the end of the exposure)

## Notes:

- a) Tests ID 06 and 07 shall be performed on test samples to perform a correct exposure in the chambers for testing. Shape and dimensions shall be approved by the laboratory; DFT on these samples shall be at the lower limit of the allowable range defined in the work instruction.
- b) Test ID 06 and 07 can be omitted, if already performed during painting system qualification on the substrate here request;

ID	Test & Checks Description	Test Method	Test Condition	Acceptance Criteria
08	Resistance to the Salt Spray	ISO 9227 AASS	Exposure time 1000 h Make a straight scratch or scribe mark through the coating to the substrate Substrate; same aluminium alloy material of the parts and painted according to work instruction used for manufacturing the series production	ISO 4628-2: 0(S0) (Blistering) degree of delamination acc. ISO 4628-8 surface delamination: $\leq 16\text{mm}^2$ (over a scratch length of 10 cm) longest delamination: $\leq 4\text{mm}$
09	Resistance to the Salt Spray	ISO 9227 NSS	Exposure: 1000 h Substrate; same steel material of the parts and painted according to work instruction used for manufacturing the series production	ISO 4628-2: 0(S0) Blistering ISO 4628-3: Ri 0 - Rusting ISO 4628-4: 0 (S0) - Cracking ISO 4628-5 0 (S0) - Flaking ISO 4628-8: $c \leq 1\text{ mm}$ and $d \leq 2\text{ mm}$ (to be verified after 24 h after the end of the exposure)

a) Test ID 08 and 09 can be omitted, if performed during painting system qualification on the substrate here request;

## 11. DOCUMENTATION

### 11.1 Documents request to the Paint manufacturer

Item	Description Item	Note
<b>1</b>	<b>System Definition</b>	
1.2	<i>Technical Data Sheet (TDS)</i>	The TDS shall contain the spreading rate
1.3	<i>Master of reference</i>	N. 15 pieces (unless otherwise agreed) for each color
1.4	<i>List of Products and Weight Analysis (dry condition)</i>	According to HR template "Painting Weight Matrix"
1.5	<i>Clause by Clause to this specification</i>	
<b>2</b>	<b>Qualification</b>	
2.1	<i>Test Reports</i>	
<b>3</b>	<b>Production</b>	
3.1	<i>Painting Recommendations</i>	Document which shall report the following recommendations: a) Surface cleaning and pretreatments based on this specification; b) Surface status before primer application c) For each coat provide: method of application; mixing ratio; pot life, flash-off time, wet film thickness, dry film thickness; viscosity of application d) Parameters of application, e) Drying conditions, curing time, interval time between f) Checks and control g) List of codes of all products to be used in work instruction.
<b>4</b>	<b>Quality Assurance</b>	
4.1	<i>Declaration of Conformity</i>	
<b>5</b>	<b>Maintenance</b>	
5.1	<i>Painting Repairing Recommendations</i>	As per painting recommendations, together the preparation of the area to be repainted
5.2	<i>List of Cleaning Products</i>	Products already tested by the paint manufacturer
5.4	<i>List of Graffiti Remover</i>	Products already tested by the paint manufacturer
<b>6</b>	<b>Logistics</b>	
6.1	<i>Recommendations for Handling, Storage and Shipment</i>	
<b>7</b>	<b>Health and safety</b>	
7.1	<i>Material Safety Data Sheet (MSDS)</i>	All listed materials
<b>8</b>	<b>Design for Environmental</b>	
8.1	<i>Environmental Declaration of Conformity</i>	Z2 template
8.2	<i>Material Declaration</i>	Z4 template

All documents shall be issued in English language.

## 12. Requirements for SEC suppliers

- a) The SEC suppliers shall comply with the requirements of this specification, taking into account, in particular in the chp.2, chp 7 a), d) and 9.2.1 f).
- b) SEC suppliers shall meet the requirements at the § 10.3 and if applicable 10.4;
- c) *As regard painting system for Zone A3,K3 and in all others case of request of deviation; SEC supplier may propose deviation, but in this case a painting systems description and a comparison with the requirements of this specification shall be provided. Reports of tests already performed shall be provided;*
- d) Interfaces of equipment or components used to fix them to the carbody shall comply with the requirements at the § 9.1.5. The request is applicable to fixation classified H and M according to DIN 25201-1 (risk level high and medium);
- e) Painting Repairing recommendations, cleaning list and graffiti remover (if applicable) tested by the SEC supplier shall be provided. The products listed here below will be used to clean the vehicles; Painting system which will be in contact with these products, shall be tested as per §10.1.1 (Test ID14) and per § 10.1.6 (Test ID 08)

Usage	Product (Manufacturer /Supplier)
Exterior cleaning (Trainwash and handbash)	Advance ALT Detergent (Bingham)
Exterior cleaning (Trainwash and handbash)	Gard RSC (Gard)
Exterior cleaning (Trainwash and handbash)	Eurowash 1000 (Chela)
Exterior Biohazard Cleaning	Guardicide (Chela)
Underframe and Removal of exterior traffic film	Eurowash 1000 Plus (Chela)
Iron Stain Removal	Eurowash ISR Thick (Chela)
Graffiti removal	Graffiti Remover 300 (Tensid) Graffiti Green (Tensid)
Biohazard and Litter bin	DP 20 Disinfectant (Arrow Chemicals)
Biohazard and Litter bin	Germfree 61 (Arrow Chemicals)
Floor lino, Gangway Bellows, Flotex Floor	Guardisan Fresh (Chela)
Floor lino	Neutra Gard (Gard)
Seat Upholstery	RM 768 iCapsol NTA-Free
All-round cleaner (hard and glazed surface) Seat covers	Speed Clean 21 (Superfine Manufacturing)
Chewing Gum Remover	Desolv Chewing Gum Remover
Biohazard Cleaning of internal surfaces or floor covering.	Guardicide (Chela)
To be used as a fogger in vehicle interior for virucidal and biocidal.	Guardicide (Chela)
Bacteria based toilet cleaner – presently under consideration for bioreactor toilets only	Bio Chela Fresh (Chela)

- f) The description of the adopted painting system and the tests reports shall be included in the corrosion control plan (CDRL List - doc. AA-6)
- g) All documents shall be issued in English language.